

Best Management Practices for Mining in Idaho

Prepared by:

*The Idaho Department of Lands in conjunction with
Other State and Federal Agencies through
The Idaho Mining Advisory Committee*

DEPARTMENT OF LANDS
954 West Jefferson
PO Box 83720
Boise, Idaho 83720-0050
Telephone: (208) 334-0200

MANUAL OF BEST MANAGEMENT PRACTICES FOR THE MINING INDUSTRY IN IDAHO

The information contained in this manual is provided to the mining community and state and federal agencies as an information and reference resource only. The Department of Lands cannot guarantee the techniques and approaches described in this manual will be effective on a particular mining site; however, it is hoped the ideas presented will assist in successfully maintaining water quality and completing reclamation projects.

The manual represents a joint effort through the Idaho Mining Advisory Committee, made up of the following state and federal agencies and organizations:

Idaho Department of Lands
Idaho Department of Water Resources
Idaho Department of Environmental Quality
Idaho Department of Fish and Game
Bureau of Land Management
USDA Forest Service, Region 1
USDA Forest Service, Region 4
Idaho Conservation League
Clark Fork Coalition
Idaho Mining Association
Independent Miner's Association

The manual is compiled and published by the Idaho Department of Lands.

All remarks and/or suggestions regarding this manual should be directed to:

Idaho Department of Lands
Bureau of Surface and Mineral Resources
954 West Jefferson Street
Boise, Idaho 83720

INTRODUCTION

This handbook presents best management practices (BMP'S) for surface, dredge and placer mining which, if implemented, will help minimize nonpoint source water quality impacts, derived from these activities, as well as promote and enhance the natural recovery of the mined site. Identification of these BMP's is mandated by Section 319 of the Water Quality Act of 1987 (also referred to as the Clean Water Act) which states, "It is national policy that programs for the control of nonpoint sources of pollution be developed and implemented." This handbook is intended to be an informational reference guide that can be used by both industry and regulatory agencies. These best management practices are recommended for use, but are not required by statute. This handbook can be used in conjunction with the U.S. Department of Interior, Bureau of Land Management Solid Minerals Reclamation Handbook (H-3042-1).

Water quality impacts can originate from increased sedimentation to surface waters from areas that are cleared for mining, roads built for access to the project site, stockpiles of topsoil, ore and waste, and stream channel alterations. Additional impacts could result from the transportation of hazardous materials, such as petroleum and ore processing reagents, as well as from naturally occurring heavy metals or other elements that may be released during mining or mineral processing. Sources contributing to nonpoint source pollution include surface runoff and water that infiltrates through soil into the ground. Of particular concern are potential cumulative impacts to the watersheds where more than one current and/or historical mining activity occurs.

A process known as the "feedback loop" has been designed to manage all nonpoint source pollution and is based on implementation of BMP's. Best Management Practices are identified through the planning of a mining operation and applied by the operator for site-specific conditions. The operator's reclamation plan, which must identify specific BMP's to be used on site, is reviewed and approved by the Department of Lands. The effectiveness of the BMP's in protecting water quality is examined by in-stream water quality monitoring. The data is then compared against in-stream criteria, developed to protect the beneficial uses of that water, by the Division of Environmental Quality.

If monitoring shows that an operation is adversely affecting the designated beneficial uses of a stream, the Department of Lands will require that an operator improve existing or implement additional BMP's to protect the beneficial uses of the stream. In addition, mining operations which are determined to have a reasonable potential for contributing nonpoint source pollution to surface waters may be required to collect and report baseline and operational water quality monitoring data to the Department of Lands.

PROCEDURE FOR USE

I. Mining Industry

This handbook should be used by the mining industry as a reference guide which contains standardized practices and procedures designed to mitigate the impacts of surface disturbing activities. The first seven chapters of the book contain generalized information pertaining to specific mining procedures and related activities. In these chapters reference is made to the best management practices that can be used to mitigate the impacts to water quality resulting from mining. Those BMP's are outlined in Sections I through V. The BMP's are described both in text form and through figures. It must be noted that BMP's are site specific; a particular BMP might not be effective to control the same problem in different geographic locations. If a series of best management practices does not work, other best management practices should be tried.

II. Government Agencies

This handbook should be used by regulatory agencies as a reference guide when evaluating the completeness of reclamation plans. BMP's outlined in this handbook may be suggested as inclusions in the plan if their implementation would possibly reduce potential impacts to water quality. It should also be used as a reference by the field person on the ground when he and the operator are attempting to mitigate existing or potential water quality impacts.

MINING OPERATIONS AND BEST MANAGEMENT PRACTICES USE

Mining operations can be divided into two general categories, surface and underground. Surface mining can further be broken down into placer mining (which includes sluicing, panning and dredging) and open-pit mining. These BMP's may also be used to minimize impacts from mineral exploration and oil, gas, and geothermal drilling. Reclamation of abandoned mined lands need to be addressed, however, it is difficult if not impossible at the present time to establish responsibility for rehabilitation work on these sites. Most BMP's in this handbook will be directed toward mitigating the adverse effects of surface mining operations.

If an operator will construct roads, the following chapters in the manual will apply:

Chapter 1 -- Access and Haul Roads

If an operator is conducting a dredge or placer mining operation wherein he will be extracting gold bearing gravel from the surface by means of a front end loader, or similar piece of motorized earth moving equipment, and washing the gravel through a washing plant (a trommel screen equipped with sluices and/or jigs), the following chapters in this handbook will apply:

Chapter 2 -- Surface Mining and Dredge and Placer Operations

Chapter 5 -- Settling Ponds, Process Water Ponds, Evaporation Ponds, Slime Ponds

If an operator is conducting a surface mining operation wherein he will be extracting metals, industrial minerals, rocks and/or sand and gravel from an open pit or quarry site, the following chapters in this handbook will apply:

Chapter 2 -- Surface Mining: Open Pits, Quarry Sites, Dredge and Placer Operations

Chapter 3 -- Waste Dumps, Spent Ore Dumps, and Ore Stockpiles.

If ore is processed at the site by means of a milling circuit wherein material will be crushed and the minerals are recovered by gravity separation, flotation and/or leaching, and the tails leave the plant as a slurry, the following chapters in this handbook will apply:

Chapter 4 -- Mill Tailings Impoundments

If the operator is extracting sand and gravel wherein water containing sediments is encountered, the following chapter in this handbook should be consulted:

**Chapter 5 -- Settling Ponds, Process Water Ponds,
Evaporation Ponds, Slime Ponds**

Underground mining operations, such as those in north Idaho's Silver Valley, are regulated by the Environmental Protection Agency, the Idaho Department of Water Resources, and the Idaho Department of Health and Welfare, Division of Environmental Quality (Air Quality Bureau). Underground mining, like surface mining, is under the Resource Conservation and Recovery Act (RCRA) and the Clean Water Act to name a few. Surface affects of underground mining are generally small and require a National Pollution Discharge Elimination System (NPDES) permit for point source discharges such as the mine adit. The Division of Environmental Quality receives monthly reports of facility water discharges. The Division of Environmental Quality provides comment on all water discharge permits and must approve EPA's NPDES permit for any operation.

If an operator is conducting underground mining operations, the following chapters of this handbook will apply:

- Chapter 3 -- Waste Dumps, Spent Ore Dumps, and Ore Stockpiles**
- Chapter 4 -- Mill Tailings Impoundments**
- Chapter 5 -- Settling Ponds, Process Water Ponds,
Evaporation Ponds, Slime Ponds**

Each previously discussed mining method or mine component has its own set of unique characteristics, however they share many of the same activities which can result in nonpoint source (NPS) impacts. The potential contributing sources are listed below.

1. Roads;
2. Open pits, quarry sites;
3. Waste dumps, spent ore dumps, topsoil and ore stockpiles;
4. Mill tailings impoundments;
5. Settling ponds, process water ponds, slime ponds; and
6. Exploration operations

During the initial mine planning stage, a site evaluation should be conducted to determine the best location for roads, stockpiles, waste dumps, tailings impoundments, settling ponds, and other related mining facilities. This should include (but not be limited to) a study of climate, topography, geology, seismicity, hydrology, hydrogeology, the history and existing status of surface and ground water, as well as the effects of past mining/milling activities, if any. The mine planner should evaluate these criteria when developing a mine plan or preparing a reclamation plan.

After the initial site information has been gathered, a water monitoring and testing program should be implemented so baseline water quality data can be compiled prior to the start-up of mining operations. This information is important as it can be used to compare existing conditions with altered conditions that might result from mining.

Climate: Climatic conditions have an impact on the ability of water to pass through soil. Climate influences runoff conditions as well as cohesive properties of soils. Verification of total annual precipitation, storm/flood frequency and seasonal temperature extremes is vital to the efficient design of erosion control structures and the proper timing of their installation. A chart showing anticipated annual rainfall may be found in Appendix D.1.

Topography: Topographical information can be used to determine the most appropriate location for roads and some mine facilities. Topography influences runoff patterns and conditions. Slope length, slope gradient, and the size of a drainage area above a mine site are important factors in controlling runoff volumes and velocities.

Geology: The geology of an area should be studied to determine rock and soil types as well as their structural characteristics. Geotechnical surveys can be used to detect subsurface geologic structures that might affect the stability of a mine site and facilities such as roads, leach pads, waste dumps, and tailings impoundments.

Soils: Soil samples should be collected and analyzed for mechanical and chemical properties. The soil type and texture influence compaction, infiltration capacity, resistance to erosion, and suitable vegetation for reclamation. Soil survey data is available from the Soil Conservation Service, local Forest Service or Bureau of Land Management offices.

Seismicity: Past and present seismic activities could influence specific location decisions because of the potential impact on the structural stability of such facilities as waste dumps, leach pads, and tailings impoundments. Information on seismic potential can be obtained from the National Earthquake Information Center in Denver, Colorado.

Hydrology-hydrogeology: Gather information on standing, flowing, or ground water within the mine site area. Determine the quality and quantity of all waters in the area. The location of water sources will impact the location of mine facilities.

Elevation/Slope/Aspect: Elevation, slope and aspect influence runoff conditions and weathering characteristics. Mid-slope roads, which have the greatest impact on water quality, are afforded better drainage than flat surfaces or roads located at the toe of a slope. South and west facing slopes are more susceptible to erosion than north and east facing slopes.

Table of Contents

Introduction	1
Procedure for Use	2
Mining Operations and Best Management Practices Use	3
Chapter 1 Access and Haul Road Construction and Use.	7
Chapter 2 Surface Mining and Dredge & Placer Operations	11
Chapter 3 Waste Dumps, Spent Ore Dumps, Topsoil and Ore Stockpiles	13
Chapter 4 Mill Tailings Impoundments	16
Chapter 5 Settling Ponds, Process Water Ponds, Slime Ponds	24
Chapter 6 Exploration or Test Hole Drill Sites	31
Chapter 7 Transportation, Storage, Handling, and Disposal of Hazardous Materials and Spill Response	32

BEST MANAGEMENT PRACTICES

Section I Soil Stabilization	38
Section II Seeding and Revegetation	54
Section III Runoff Collection	68
Section IV Runoff Dispersion	89
Section V Sediment Collection	95

APPENDICES

Appendix A Existing Programs & Regulatory Authorities	
Appendix B State/Federal Mine Permit Guide	
Appendix C Applications	
Appendix D Technical Information and References	

GLOSSARY OF TERMS

REFERENCES CITED

Published 11/16/92

Chapter 1: ACCESS AND HAUL ROADS

Best management practices should be selected so that soil movement can be minimized. They should be used to reduce the volume and velocity of runoff water. Best management practices can help provide adequate drainage on roadways so that the road surface, side slopes and borrow areas can be stabilized and do not contribute sediment to surface water.

LOCATION AND DESIGN

Avoid locating roads near critically erodible or environmentally sensitive areas such as natural drainages, lakes, ponds, springs, sites with high water tables, floodplains, and wetlands. If roads are located adjacent to water courses, leave an undisturbed vegetated buffer strip between the road and the stream. The recommended width of the buffer strip is 25 feet from a Class II stream and 75 feet from a Class I stream.

Avoid locating roads on steep slopes where shallow, coarse textured soils exist. It is hard to stabilize fills in these regions and the road will be subject to surface erosion and slope failure.

Avoid locating roads in landslide areas, narrow canyons, or in areas where there are tension cracks and high cut banks.

Roads should be located on natural benches, ridges, and rock formations that tend to dip into the slope. In addition, road widths and grades should be kept to a minimum.

Design roads to match natural contours. This should reduce the number and size of cut and fill slopes.

Special geologic factors that should be considered in evaluating slope stability include, resistance of the rock, slope of bedding planes relative to ground slope, ground water conditions, and structural controls.

Erosion problems can be avoided during construction by anticipating and preparing for them in advance. After a site evaluation has been completed, select the most stable route. The road should be designed to accommodate and control anticipated runoff and sediment volume. Determine erosion control needs and incorporate these control measures, in the form of BMP's, into the road design specifications. This will ensure timely application and proper construction of best management practices.

CONSTRUCTION

The effectiveness of a particular best management practice depends on proper design, placement, and timing.

During construction an operator should:

1. Install drainage and sediment collection systems prior to beginning road construction. These structures should be placed adjacent to the proposed route to catch sediment laden runoff or to divert surface water away from the roadway. Refer to the following BMP's:

- | | | | |
|--------|----------------------------------|-----|-------------------------|
| I.11 | Biotechnical Stabilization | V.1 | Straw Bale Barriers |
| III.1 | Diversion Ditch/Dike | V.2 | Sediment Traps |
| III.2 | Interceptor Trench | V.3 | Vegetated Buffer Strip |
| III.4 | Siltation Berm | V.4 | Silt Fence/Filter Fence |
| III.10 | Rolling Dips | V.5 | Brush Sediment Barrier |
| III.11 | Road Sloping | V.7 | Slash Filter Windrow |
| III.12 | Roadway Surface Water Deflectors | | |

2. Re-establish vegetative cover on disturbed land as soon as possible during the construction phase and after it is completed. It is important to revegetate the cut and fill slope as soon as possible after construction is completed to help reduce erosion. Refer to the following BMP's:

- | | | | |
|-----|------------------|------|-------------------|
| I.3 | Mulch-Straw | II.4 | Broadcast Seeding |
| I.4 | Mulch-Wood Chips | II.8 | Fertilizer Use |

3. Install drainage facilities in the roadway to protect road work as it is completed. Refer to the following BMP's:

- | | | | |
|-------|---------------------------|--------|----------------------------------|
| III.3 | Open Top Box Culverts | III.10 | Rolling Dips |
| III.5 | Waterbars | III.12 | Roadway Surface Water Deflectors |
| III.6 | Corrugated Metal Culverts | | |

4. Routinely inspect and clean sediment control structures and minimize the amount of bare soil. Refer to the following BMP's:

- | | | | |
|-----|-------------------------|------|------------------------------|
| I.1 | Matting-Plastic | II.4 | Broadcast Seeding |
| I.2 | Erosion Control Blanket | II.3 | General Planting and Seeding |
| I.3 | Mulch-Straw | II.8 | Fertilizer Use |
| I.4 | Mulch-Wood Chips | | |

5. Blend the final construction contours with surrounding topography to maintain natural drainage patterns where possible.

Dust and runoff on roadways can be controlled by placing a layer of crushed rock on the surface of the road. The crushed rock should be at least 3/4 inch in size and layered to a depth of between 2.5 and 3.5 inches (.2 - .3 of a foot). Rock size and depth of placement will depend on the volume of traffic and weight limits of vehicles allowed on the road.

Low impact bridges, referred to as Copeland Crossings, can be used to span streams when roads must traverse waterways. They are designed to be used infrequently for a one to two year period. Copeland Crossings can be constructed of lodgepole that are at least seven inches in diameter at the butt, or any other suitable similar diameter tree. Trees should be cut to a length long enough to span the creek or stream. The cut logs should be placed across the stream (with the ends resting on each bank) with a track hoe or backhoe equipped with a thumb or clamshell attachment. A second layer of shorter length, four inch diameter, logs can be placed on top of the original span, perpendicular to the direction of the placement of the foundation logs. Planks can then be placed on top of the two log layers. Rotten logs or duff should be placed on the roadway for a distance of 25 feet on either side of the approach to the bridge. This will help bring the roadway up to the elevation of the crossing. The weight load of vehicles using the bridge should be considered when logs are being cut and installed.

MAINTENANCE

Road maintenance activities, relative to best management practices, focus on routine cleaning of drainage structures and sediment traps to remove debris and maintain efficiency. Inspection and cleaning operations should follow major storm events. Inspection of revegetated sites should be conducted annually until growth has been established, to determine additional seeding and/or fertilizing needs.

ROAD CLOSURE

Specific procedures for closure are highly variable but all are intended to return the site to as natural a state as possible with minimal soil or drainage disturbance. The road should be recontoured to blend with existing surface water drainages and stabilized with vegetation. Refer to the following BMP's:

- | | | | |
|-----|-------------------------|------|----------------------------------|
| I.1 | Matting-Plastic | II.2 | Seedbed Preparation |
| I.2 | Erosion Control Blanket | II.3 | General Planting and Seeding |
| I.3 | Mulch-Straw | II.4 | Broadcast Seeding |
| I.4 | Mulch-Wood Chips | II.6 | Vegetative Planting |
| | | II.8 | Fertilizer Use |
| | | II.9 | Maintenance of Revegetated Areas |

If the road is not recontoured, the roadbed should be ripped. Berms should be removed or broken at regular intervals to aid in lateral drainage. Self maintaining drainage systems must be installed and the site must be seeded. Refer to the following BMP's:

- | | | | |
|--------|----------------------------------|------|------------------------------|
| I.3 | Mulch-Straw | II.2 | Seedbed Preparation |
| I.4 | Mulch-Wood Chips | II.3 | General Planting and Seeding |
| | | II.4 | Broadcast Seeding |
| | | II.6 | Vegetative Planting |
| | | II.8 | Fertilizer Use |
| III.5 | Waterbars | | |
| III.10 | Rolling Dips | | |
| III.12 | Roadway Surface Water Deflectors | | |

If structural features such as bridges and culverts are removed, soil disturbance should be minimized and all debris should be removed from within fifty (50) feet of a drainage to help prevent sedimentation. Fill material should also be removed from below the high water mark and stabilized in a location well away from the stream bank.

Chapter 2: SURFACE MINING AND DREDGE AND PLACER OPERATIONS

This chapter describes procedures for preventing and minimizing water pollution during construction and mining.

When locating the boundaries of a surface mine, a buffer zone of undisturbed riparian vegetation must be left between the area to be worked and an existing stream channel or live body of water. If this is not possible, a stream alteration permit will be required from the Idaho Department of Water Resources (IDWR). Consult the Stream Channel Alteration Rules and Regulations issued by the Idaho Department of Water Resources and the following BMP's:

- | | |
|--------------------------------|-----------------------------------|
| III.8 Stream Alteration | V.3 Vegetated Buffer Strip |
| | V.5 Brush Sediment Barrier |
| | V.7 Slash Filter Windrow |

During the initial site preparation-construction phase of any surface mining operation, limit the amount of unvegetated ground. Best management practices should be installed prior to construction to limit and control runoff from unvegetated areas. Refer to the following BMP's:

- V.1 Straw Bale Barriers**
- V.4 Silt Fence**
- V.5 Brush Sediment Barriers**
- V.6 Sediment Ponds**
- V.8 Log and Brush Check Dams**

Design of open pits should include measures which prevent surface water from entering the workings. This can be accomplished by minimizing development near surface waters or by diverting streams and/or other surface water around developed areas. There may be situations, after mining is completed, where allowing surface water to flow into a pit would be preferable to creating or maintaining diversions around the pit. If water enters the pit, it may act as a recharge area to ground water and filter out sediments. Refer to the following BMP's:

- III.1 Diversion Dike**
- III.8 Stream Alteration**

When mining begins, topsoil and overburden should be segregated and stockpiled for use in reclamation. Topsoil stockpiles that will not be used within a year should be graded and seeded to prevent wind and water erosion and to help keep nutrients in the soil. Limit unnecessary materials handling by locating stockpiles away from potentially affected lands.

Each phase of the operation should be reclaimed concurrently during mining. This will help reduce erosion and water quality impacts and will spread reclamation costs over the life of the mine. During operations, inspect and clean sediment control structures to maintain their efficiency. If the best management practices are not effectively controlling sediment, consider an alternative best management practice or series of best management practices.

Before mining operations begin and during mining, an operator must consider, and plan for, how the site will be reclaimed. Reclamation measures may include but are not limited to:

1. Open pits should be backfilled where economically possible. Fill the pit or quarry with waste material and regrade to blend with the surrounding contour. Benching or terracing should also be considered to break up long slope lengths and control erosion. Establish positive drainage so that stagnant water ponds will not be created in backfilled pits. Use available topsoil or similar productive material to prepare the pit surface for revegetation. Note: A six (6) inch deep layer of topsoil is the minimum for revegetation efforts; and a twelve (12) inch deep layer is preferred.

If it is not practical to backfill the pit, the benches should be maintained as they provide stable surfaces for vegetative growth. When possible, the benches should be ripped, topsoiled, and seeded. Refer to the following BMP's:

- | | | | |
|------|------------------|------|------------------------------|
| I.3 | Mulch-Straw | II.1 | Topsoiling |
| I.4 | Mulch-Wood Chips | II.2 | Seedbed Preparation |
| | | II.3 | General Planting and Seeding |
| | | II.4 | Broadcast Seeding |
| | | II.8 | Fertilizer Use |
| IV.1 | Serration | | |
| IV.2 | Benching | | |

2. Other surface mining operations should be recontoured to the approximate original contour, topsoil replaced and seeded. Refer to the following BMP's:

- | | | | |
|-----|------------------|------|----------------------------------|
| I.3 | Mulch-Straw | II.1 | Topsoiling |
| I.4 | Mulch-Wood Chips | II.2 | Seedbed Preparation |
| | | II.3 | General Planting and Seeding |
| | | II.4 | Broadcast Seeding |
| | | II.5 | Drill Seeding |
| | | II.6 | Vegetative Planting |
| | | II.8 | Fertilizer Use |
| | | II.9 | Maintenance of Revegetated Areas |

Chapter 3: WASTE DUMPS, SPENT ORE DUMPS, AND ORE STOCKPILES

Decisions on how to protect water quality should be based on overall practicability while at the same time weighing factors such as economic feasibility, local conditions, and maintenance requirements. The operator must plan to control or eliminate toxic substances in the dump material.

WASTE DUMPS AND/OR SPENT ORE DUMPS:

LOCATION:

1. Locate waste dumps or spent ore dumps away from surface waters, springs, seeps, and wetlands. If this is not feasible, water should be diverted around the dump and/or a drain field should be installed under the dump. The drain field or diversion dike should discharge into a settling pond. Refer to the following BMP's:

- | | | | |
|-------|----------------------|-----|----------------|
| III.1 | Diversion Dike/Ditch | V.6 | Sediment Ponds |
| III.7 | Drain Fields | | |

2. Enhance the long term mass stability of a dump by locating and constructing it so that the potential for failure is minimized. This can be done by evaluating the geologic nature of the material to be placed in the dump and locating the dump in a geologically stable area. Avoid faults, dense joint systems, and landslide areas. Particle size distribution of the waste and the presence or absence of clay can also affect the stability of the dump depending on how the dump is constructed. Locating dumps on flat topography is preferable to sloped terrain. When material is placed on a slope greater than 3:1 (20°), foundation preparation requirements are critical to dump construction.

3. Where acid mine drainage may be generated by oxidation of sulfides, prevention measures should be taken. These measures may include impermeable caps and liners, surface water diversions, and/or blending acid consumption materials such as limestone with wastes. Where preventive measures are impractical, water treatment will be necessary until acidic discharge meets water quality standards. Note: Some knowledge of mineralogy, hydrology and physical characteristics of an area can help prevent potential acid water problems caused by mining.

4. Any water that runs off the surface of a dump should be diverted behind siltation berms, into catch basins, into sediment ponds, or through silt fences. Refer to the following BMP's:

- | | | | |
|-----|---------------------|-----|--------------------------|
| V.1 | Straw Bale Barriers | V.2 | Sediment Traps |
| V.4 | Silt Fence | V.5 | Brush Sediment Barriers |
| V.6 | Sediment Ponds | V.8 | Log and Brush Check Dams |

CONSTRUCTION AND LOADING CHARACTERISTICS:

1. Remove topsoil from the dump construction area; store, and stabilize for future use.
2. If necessary, construct a drain field at the proposed dump site.
3. Construct the dump in successive lifts, starting at the toe. A single lift should not exceed fifty (50) feet in height.
4. Some material, such as sulfidic waste, should be segregated when placed on the dump so it does not come in contact with surface water or leach toxic substances into the ground water. Other materials, such as those with a high clay content, should be mixed with rocks and debris. This should help prevent failure planes from forming in the dump.
5. Artificial supports, such as retaining walls, could be used when building waste or spent ore dumps. Retaining walls installed in conjunction with a drainage system (as shown in Figure 3-1) may be used to help support the toe of the dump while draining excess water from within the dump, which helps relieve pore pressure. Bracing piling and wire mesh can also be used to help control rock spall (rock breaking off in layers parallel to the surface).

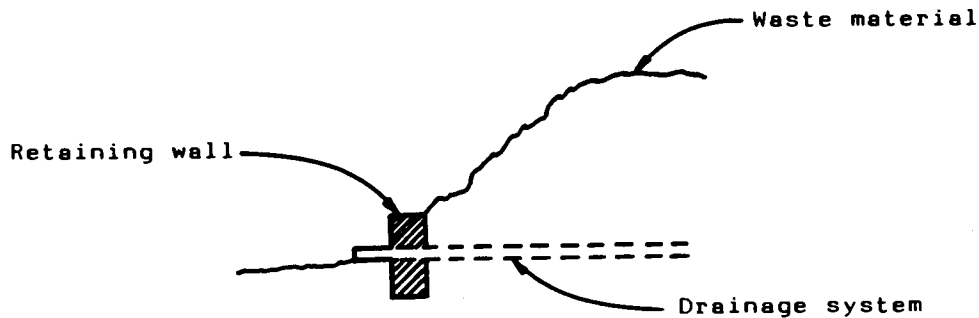

FIGURE 3-1

RECLAMATION:

The dump should be reclaimed upon completion of the mining operation or concurrently if sections of the dump are no longer in use.

Reclamation efforts should include grading and recontouring of the dump surface to a 3:1 slope or flatter, placing topsoil on the sides and top of the dump and applying seed, fertilizer and mulch. At a minimum, all exposed soil should be seeded with grasses and/or shrubs to increase long term stability and reduce wind and water erosion. Refer to the following BMP's:

I.3	Mulch-Straw	II.3	General Seeding and Planting
I.4	Mulch-Wood Chips	II.4	Broadcast Seeding
		II.5	Drill Seeding
		II.6	Vegetative Planting
II.1	Topsoiling	II.8	Fertilizer Use
II.2	Seedbed Preparation	II.9	Maintenance of Vegetated Areas

If the waste material is highly acidic and if there is not enough topsoil available to establish vegetative growth, lime may need to be applied to the dump surface to adjust the pH of the waste material so that vegetation will grow. More than one lime treatment may be required to established a self-sustaining vegetative cover.

TOPSOIL AND ORE STOCKPILES:

DESIGN CRITERIA:

1. Locate stockpiles as far from surface waters, springs, seeps, and wetlands as possible.
2. Place the stockpile on a geologically stable surface.
3. Stockpiles, which are not scheduled to be processed within a reasonable length of time, should be stabilized as soon as possible after construction, to prevent unnecessary erosion by wind and water. If the stockpile contains sulfidic ore, measures should be taken to prevent the formation and runoff of acidic water. These measures may include placing an impermeable cover over the stockpile and/or constructing settling ponds below the stockpile to catch and contain runoff water. Seeding topsoil stockpiles will help to keep the topsoil biologically active and retain its value as a plant growth medium. Refer to the following BMP's:

III.1	Diversion Dike/Ditch	V.2	Sediment Traps
III.2	Interceptor Trench	V.4	Silt Fence
III.4	Siltation Berm	V.5	Brush Sediment Barrier
		V.6	Sediment Ponds
V.1	Straw Bale Barrier	V.7	Slash Filter Windrow

Chapter 4: MILL TAILINGS IMPOUNDMENTS

As outlined in the introduction to this manual, a detailed site analysis should be conducted as a first step in tailings impoundment design. In addition, the design characteristics should take into account specific needs of the project as they relate to tailings disposal. Refer to the following publications for more detailed information on tailings impoundments:

1) Design and Construction of Tailings Dams, edited by David Wilson, July 1981, Colorado School of Mines Press, Golden, Colorado.

2) Design of Dams for Mill Tailings, C.D. Kealy and R.L. Soderberg, USBM Information Circular 8410, U.S. Department of Interior, Bureau of Mines.

The hydrologic characteristics of the site are an important consideration as surface and ground water will either have to be diverted around the impoundment, passed through the dam or stored behind it. The National Oceanic and Atmospheric Administration (NOAA) weather atlas or the snow load report generated by the University of Idaho are sources of hydrologic data. If the dam is built in an area where no discharge is allowed, the storage capacity of the structure must be a major consideration. The tailings impoundment must be designed to contain all process water and be able to hold additional precipitation from a probable maximum storm event.

The geology and structural stability of the foundation material, upon which the dam is to be built, also needs to be analyzed. Sound foundation material should help ensure that the dam is stable. Drilling and/or test pits dug with a backhoe could be used in foundation studies. A geologist or geotechnical engineer must be consulted for assistance with these studies.

Both the Idaho Department of Water Resources and the Idaho Department of Health and Welfare (Division of Environmental Quality) have rules and regulations that have to be followed in tailings impoundment design and construction. For specific authorities and requirements, see Appendix A.

Before dam construction begins, surface water should be diverted around the impoundment area. This will decrease the amount of water that must be stored behind the dam. Diversion dikes and interceptor trenches can be used to divert water. If the water contains sediments, it will have to be clarified before it can be discharged. A settling pond will need to be constructed to hold the sediment laden water. Refer to the following BMP's:

III.1	Diversion Dike/Ditch	V.6	Sediment Ponds
III.2	Interceptor Trench	V.8	Log and Brush Check Dams
III.8	Stream Alterations/Diversion		

Ground water seepage into the impoundment area can be controlled by lining the pond. It may be necessary to install a drain field under the liner so that seepage does not build up between the liner and saturated soil under the pond. A seepage build up could cause hydrostatic pressure to be exerted against the liner (if it is a synthetic liner) which could result in failures of seams and welds.

A liner will also prevent water contaminated with leachates and/or process chemicals from coming in contact with ground water. The pond can be lined with an impermeable clay or a synthetic material such as polyvinyl chloride (PVC) or high-density polyethylene (HDPE).

Tailings impoundments designed to hold cyanide solutions, sulfide tailings, or phosphate slimes must be water tight. Earth dam construction techniques are usually used in these instances. Earth dams are constructed from sand, gravels, and other "natural" pervious and impervious materials found at the site where the structure is to be built. This type of dam should be designed and constructed by a qualified specialist. Earth dam construction design must be approved by the Idaho Department of Water Resources if the structure will be over thirty (30) feet high. Refer to the following publications for additional information on dam construction: Earth and Earth Rock Dams, Engineering, Problems of Design and Construction by J.L. Sherard, et al.

There are several conventional methods of tailings dam construction; they are:

1. Dams built using mill tailings as the construction media; these include:
 - a. The upstream construction method.
 - b. The downstream construction method.
2. Dams built using borrow material as the construction media.

DESIGN CRITERIA:

1. Mill tailings impoundments should be designed by a qualified specialist (geotechnical engineer) in accordance with current engineering practices.
2. The foundation material should be tested to determine it's structural characteristics. Incompetent subsoil should be removed before construction begins. Build the starter dike on a firm base, free of organic material.
3. Excavate a "keyway" trench through the pervious foundation material into the impervious zone. The keyway trench should prevent water from seeping between the foundation and the starter dike. Backfill the trench with impervious material free of organic debris. Compact the material. Build the starter dike on the keyway trench. (See Figure 4-1)

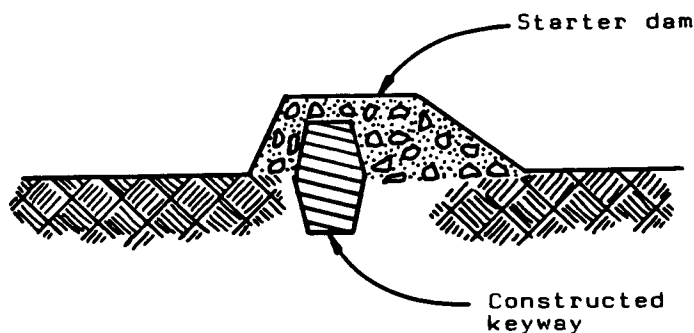

Keyway

FIGURE 4-1

4. Do not construct the dam of homogeneous materials. Construction with heterogeneous materials will help control seepage and enhance structural stability. Starter dikes should be constructed of coarse rock, gravel mixed with sand, or other pervious materials. The dike should be erected in well compacted lifts.

5. The control of free water and seepage water is critical when designing tailings dams or waste disposal systems. When impounding tailings which are not very permeable, the disposal area should be large enough to hold the tailings while not increasing the surface level of the impounded material more than two (2) feet annually. As the impoundment area is built upstream of the dam, place materials of constantly decreasing permeability in this area. The pooled water should be kept as far away from the dam as possible.

6. When depositing tailings in the impoundment, place them in a relatively thin layer. Allow the tailings to partially dry out before placing the next layer. This will make the tailings material more stable and easier to reclaim.

7. When using the tailings impoundment, care should be taken to ensure that water is kept as far away from the face of the dam as possible. This can be done by decreasing the volume of water in the pond by reusing it for processing, by installing a decant system, or by pumping water out of the pond. Decant systems should be designed and installed by a qualified engineer. Improperly installed decant systems could cause piping which weakens the dam structure. If water is pumped out of the pond it must be relatively free of sediment and other contaminants. It should be pumped onto vegetated ground where it will not cause erosion or reach surface waters. The Idaho Department of Health and Welfare, Division of Environmental Quality, must approve plans for land application of wastewater. See Appendix A

DAMS BUILT FROM MILL TAILINGS

Upstream Deposition Method

Before construction commences on the starter dike, the site should be cleared of all topsoil and vegetation. The starter dike can then be built on a base free of organic material.

Build the starter dike on a firm, structurally sound foundation. Use coarse rock, gravel mixed with sand, or other permeable material for construction. The starter dike will act as the toe of the dam once build-up with mill tailings begins. (See Figure 4-2) The upstream side of the dike should grade into sand so tailings will not be piped through rock once deposition starts. (See Figure 4-3)

Drain fields may necessary beneath the starter dike (especially when the downstream construction method is used) to help reduce the water level at the face of the starter dike. Water from the drainfield may have to be directed behind a second dam or into a settling pond and then pumped back into the tailings impoundment if no discharge is allowed. Refer to the following BMP's:

III.7 Drain fields

V.6 Sediment Ponds

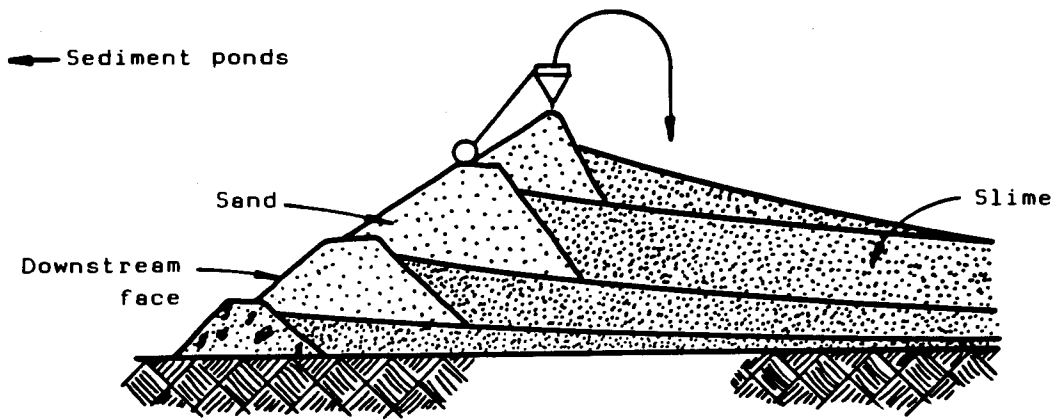

UPSTREAM DEPOSITIONAL METHOD A

FIGURE 4-2

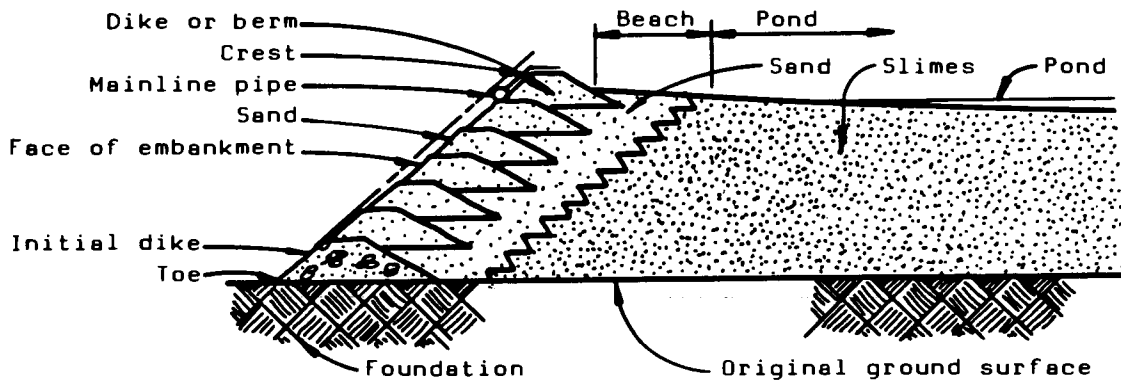

UPSTREAM DEPOSITIONAL METHOD B

FIGURE 4-3

After the starter dike has been completed, the main tailings disposal pipeline can be laid around the periphery of the dike. Bleeder lines, discharging into the pond, should be attached to the main line every ten (10) to fifty (50) feet depending upon the size of the dam. Cyclones can be used in conjunction with piping systems mentioned above, as cyclones help separate the coarser material from the slimes so they can be segregated into different parts of the pond.

Dams built using the upstream deposition method have several advantages over other designs including : 1) lower construction costs, and 2) the speed with which the dam can be raised. (Using cyclones increases the speed of rise and also ensures a more uniform distribution of fines along the length of the starter dike.) Some disadvantages include: 1) the dam is built on previously deposited unconsolidated tailings, and 2) under static (motionless) loading conditions the dam height is limited because of the potential for sheer failure in a downstream direction. Dams built using the upstream deposition method are best suited for minor tailings impoundments that are not intended to be very high or hold large volumes of tailings and/or water.

Downstream Deposition Method

Build the starter dike as described in the upstream deposition method.

The downstream deposition method discharges coarse material around the outside of the starter dike while depositing the slimes on the inside. Cyclones uniformly spaced around the periphery of the dike are used to segregate coarse materials from the fines. This deposition method creates a rectangular dam (See Figure 4-4) which is both stable and safe. Considerable labor is required to move and maintain the cyclones.

Dams built using the downstream method have several advantages over the upstream method: 1) Larger, higher, and safer dams can be constructed using this method, 2) No part of the embankment is built on previously deposited material. This should make the dam more stable. One drawback to this method is the large volume of coarse material needed over time to increase the elevation of the dam. As the dam gets higher, larger volumes of coarse material will be required to retain the rectangular shape.

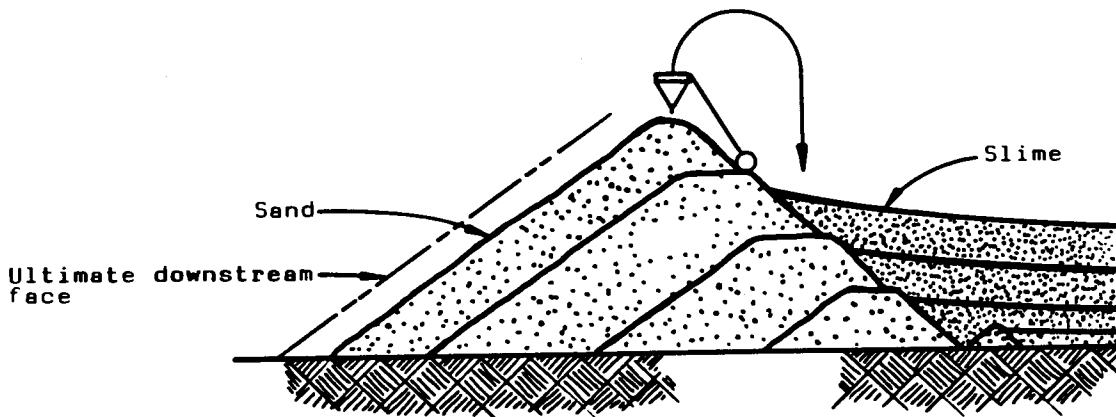

DOWNSTREAM DEPOSITIONAL METHOD

FIGURE 4-4

Dams Built of Borrow Material

This type of dam should only be used when tailings are not going to be deposited by peripheral discharge, or when uncontaminated slime is to be impounded, or when sand is deposited adjacent to the dike. Tailings sand should be dumped at the high side of the impoundment, adjacent to the dike (See Figure 4-5A).

Build the dike of a compacted mixture of clay, sand, and gravel. Build it in lifts. Compact each lift before the next lift is added.

The downstream material in the dike should be more permeable than the material deposited upstream. (See Figure 4-5B)

Sand or slime should be deposited adjacent to the dike, and water should be kept away from the dam surface.

DAM STABILITY CORRELATED WITH ZONING

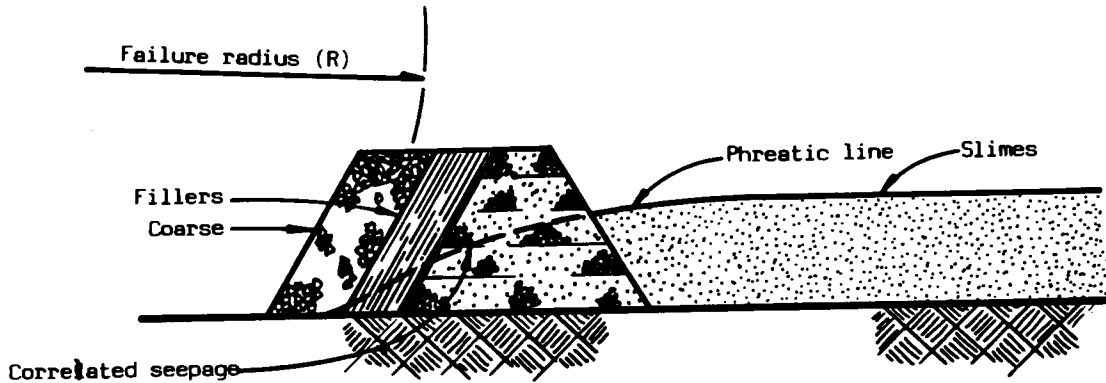

FIGURE 4-5A

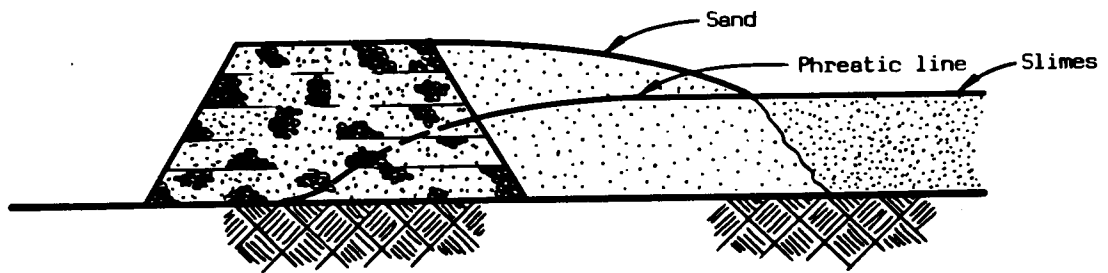

FIGURE 4-5B

RECLAMATION OF TAILINGS IMPOUNDMENTS

Upon completion of the mining project, both the tailings and dam need to be stabilized and reclaimed.

The tailings can be stabilized, in part, by dewatering. This occurs naturally by evaporation. Evaporation rates can be increased by trenching the tailings, which increases the exposed surface area. The tailings impoundment could also be dewatered by land applying non-toxic excess water.

If tailings cannot be adequately dewatered by evaporation, other methods will have to be used to stabilize the tailings. Coarse waste rock can be mixed with the tailings by pushing material from the edge of the pond toward the center of the impoundment. Heavy equipment with low surface pressures must be used for these operations. The tailings may also be covered with a layer of coarse waste rock, overburden, or an organic product such as straw or bark. This will help prevent wind and water erosion if vegetation cannot be established on the site.

Tailings that are difficult to dewater can be covered with a geotextile fabric or capped with clay. Capping tailings that have not been dewatered could cause future stability problems in the tailings impoundment. The potential exists for the build up of excess pore pressure in the tailings which could cause mobilization of the solid material. Capping may help prevent the infiltration of water into the tailings and reduce the potential for the formation of acid water in the tailings. The geotextile fabric must be well anchored at the edges of the pond and welded together where strips are laid adjacent to each other.

After the tailings have been dewatered and stabilized, they should be covered with topsoil and vegetated. If the tailings are acidic, lime may have to be applied before topsoil is spread, to adjust the pH. Refer to the following BMP's:

- | | | | |
|------|------------------|------|----------------------------------|
| II.1 | Topsoiling | II.2 | Seedbed Preparation |
| II.3 | General Planting | II.4 | Broadcast Seeding |
| II.5 | Drill Seeding | II.6 | Vegetative Planting |
| II.8 | Fertilizing | II.9 | Maintenance of Revegetated Areas |

During reclamation, diversion ditches should be cleaned out and maintained to divert water away from the site after it has been abandoned. Keeping surface water away from a reclaimed site can greatly reduce the potential for flooding, mass failure, and acid water generation which historically has been a major problem with abandoned tailings impoundments.

RECLAMATION OF THE DAM SURFACE

If feasible, the dam face should be sloped to 5:1 by adding fill material (overburden, non-toxic coarse tailings, waste rock) to the downslope side of the dam. (See Figure 4-6A) This will create a gentle slope that should help minimize erosion. Topsoil should then be placed on the dam face and the area seeded.

Another alternative is to place graded, coarse rock or riprap on the face of the dam to a depth of three (3) to six (6) feet. (See Figure 4-6B) This will help prevent water from running off the face of the dam and eroding it.

A third alternative for reclaiming the surface of the tailings dam is to cross ditch the face of the dam parallel to the contour. The grade of the ditches should not be less than 1% or greater than 5%. It might be necessary to line the ditch or seed it to decrease sediment production. This makes the ditches more stable, requiring less maintenance after the site has been abandoned.

METHODS OF TAILING DAM STABILIZATION USING
A STABILIZING FILL AND USING A ROCK DRAIN

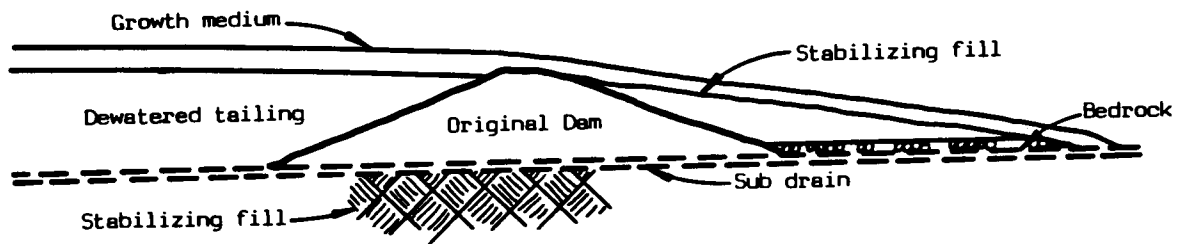

FIGURE 4-6A

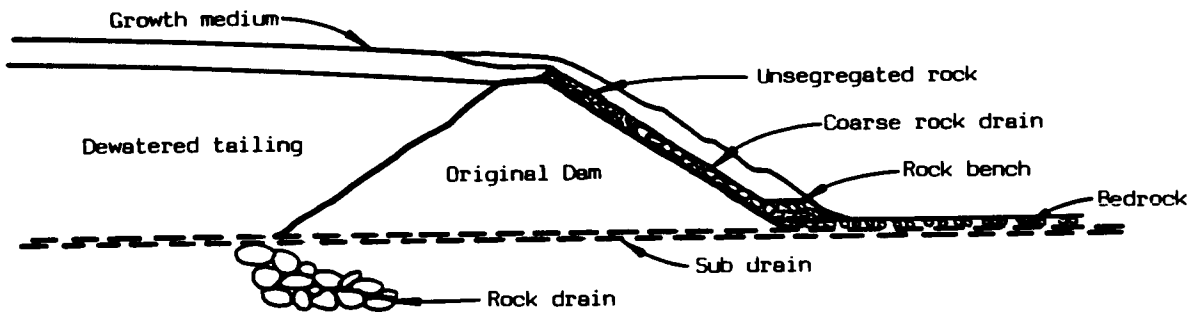

FIGURE 4-6B

The purpose of these BMP's is to ensure that settling ponds used in dredge and placer mining, process water ponds, evaporation ponds, and slime ponds are designed, operated, and reclaimed so that nonpoint source water pollution is minimized and water quality protected.

Both the Idaho Department of Water Resources and the Idaho Department of Health and Welfare (Division of Environmental Quality) have rules and regulations that may apply to settling pond design and construction. See Appendix A for specific authorities and requirements.

Settling ponds are used as:

1. Impoundments for process contaminated water derived from floating or dry land dredges, washing plants, sluicing, or other forms of placer mining that can deposit significant amounts of sediment into surface water.
2. Impoundments for sediment laden water running off excavated or stripped lands.
3. Impoundments designed for percolation, infiltration or evaporation of water.

Process water ponds are used as:

1. Make-up water ponds for dredge and placer mining, surface mining, or milling operations.
2. Make-up water or holding ponds to store clean water for placer mining operations.
3. Recycle ponds for reducing the volume of fresh make-up water used in an operation.

Evaporation Ponds are used as a means of getting rid of process water either by evaporation, percolation, or infiltration without discharging it.

Slime ponds are used in the phosphate industry for the storage of phosphatic clay waste derived from the beneficiation of phosphate ore.

PRE-MINING SITE EVALUATION

Before commencing construction for mining operations that require the use of ponds, conduct a site evaluation, including adequate sampling, to determine the economic extent of the ore body as well as the best location to set up the plant and build support facilities. This information will provide guidelines for determining the amount of surface to be uncovered in the initial construction phase, as well as assist the miner in determining the size and location of settling pond(s).

Analyze the soil at the site to determine the percentage of clay, sand, and silt it contains. This information will dictate the amount of time water must be retained in the pond to allow sediments to settle out and will impact the size and number of ponds needed for the mining operation. Suspended solids and sediment from sandy soil will settle faster than those high in clay or silt. Note: Discharging water from a settling pond to a stream requires a National Pollutant Discharge Elimination System (NPDES) Permit issued by the Environmental Protection Agency.

LOCATION CRITERIA

Settling ponds may either be permanent or moved during the course of mining. The following criteria should be considered when locating ponds:

1. Ponds should be located in a geologically stable area, at least fifty (50) feet away from streams or other surface waters.

2. Ponds should be kept out of active floodplains. This will eliminate the need for diverting streams around the ponds and will reduce reclamation requirements. If a pond is in a flood plain, all the sediment must be removed and the area stabilized upon completion of the mining project.

3. Ponds should be located so all surface water may be diverted around them. This might necessitate diverting streams and other surface water away from the site. Refer to the following BMP's:

III.1	Diversion Dike/Ditch	III.8	Stream Alteration
III.2	Interceptor Trench		

4. Ponds should be located so ground water seepage into the pond is kept at a minimum. This can be done by lining the pond with bentonite clay or other impermeable liners, or by installing cut-off trenches around the pond to decrease ground water infiltration. If the pond is lined, a drain field may have to be installed below the liner to reduce hydrostatic pressures against the liners caused by the ground water.

DESIGN CRITERIA

1. Settling ponds should be designed by a qualified specialist in accordance with current engineering practices.

2. Several settling ponds in series are often preferable to one large pond. (See Figure 5-1) Water can be retained for a longer period in multiple ponds, thus allowing sediments more time to settle out before water is discharged. One pond in the series might be the principle sediment trap while another could be used to hold "clarified" water that could be recirculated through a processing plant.

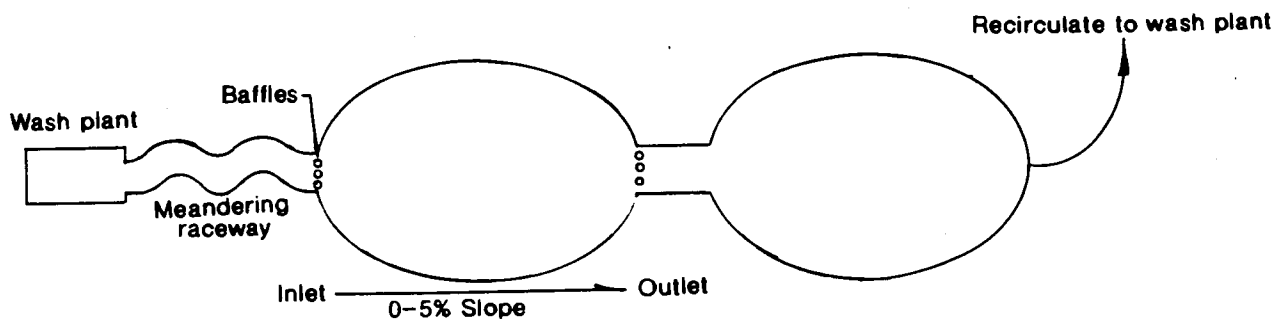

STANDARD SETTLING PONDS IN SERIES

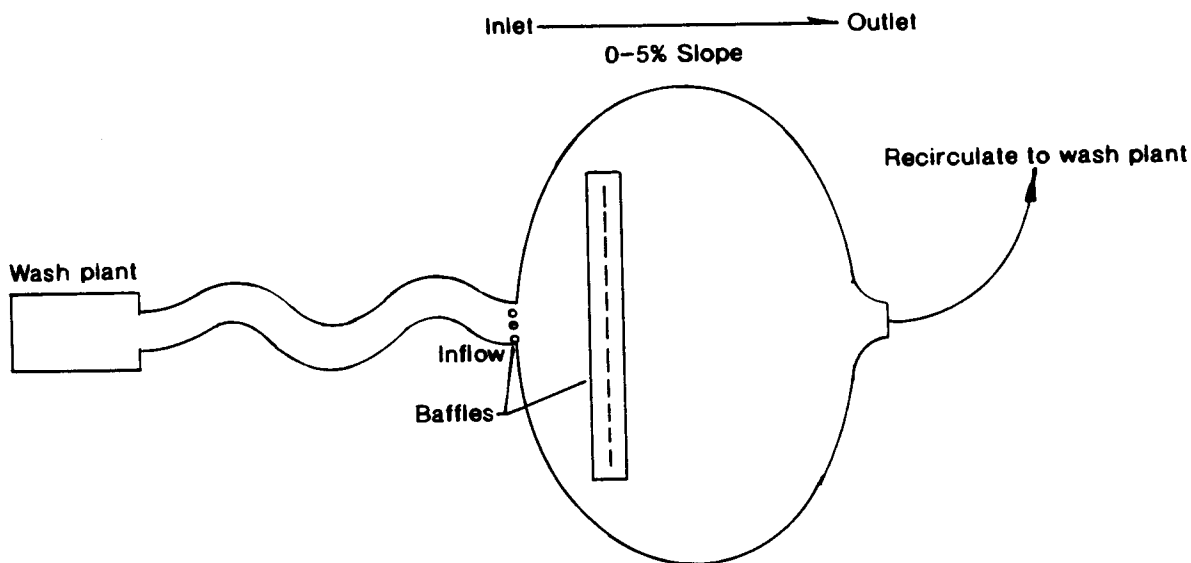

SETTLING POND WITH BAFFLES

DIAGRAM OF SETTLING PONDS FOR PLACER MINING
FIGURE 5-1

3. Ponds should be designed so their length is greater than their width. A 2:1 ratio is adequate, although a 5:1 ratio is preferred. A long length to width ratio helps reduce the velocity of water flowing through the pond, which increases the stability of the embankment. Reduced velocities also enhance the settlement of solids.

4. Design the pond so that it is large enough to contain all sediment laden process water as well as seepage, surface runoff, and precipitation from the design storm event. The pond must be large enough to provide a minimum freeboard of two (2) feet at all times. It is beneficial if size constraints conform to the physical configuration of the site.

CONSTRUCTION CRITERIA

1. If the pond cannot be built below ground level, build the pond embankment on clean, stable foundation material. This will help prevent seepage between the embankment and the foundation material. Seepage could cause piping and subsequent failure of the embankment.

2. Construct the containment embankment of well compacted, competent soil, free of organic debris.

3. Settling ponds can also be excavated below ground level with a compacted embankment placed above the ground surface as an additional safety factor. This method also increases the holding capacity of the pond (See Figure 5-2). If ponds are excavated below ground level, the foundation should be constructed so water cannot seep out of the pond into adjacent streams or other surface waters.

4. Depending upon whether the ponds will be operated as an open (discharging) or closed (non-discharging) system, a spillway will need to be installed so sediment free water can be decanted. In all cases, an emergency spillway must also be installed. Spillways must be riprapped with a coarse material to prevent erosion of the toe of the dam. Anti-seep collars must be placed around spillways to prevent seepage and eventual washout of the spillway.

5. The settling pond must be completed, ready for use, and all surface flows should be diverted around the pond, before general mining activities commence.

OPERATING PARAMETERS

1. While operating do not fill the pond with solid sediments exceeding 60% of the designed storage volume. If this limit is reached, some of the sediments should be removed and deposited elsewhere or used for reclamation.

2. Always maintain at least two (2) feet of freeboard in the ponds. This is especially important during spring runoff, periods of high precipitation, and for non-discharging ponds.

3. At the close of the mining season, decant sediment free water onto vegetated ground to allow sufficient freeboard for direct precipitation during seasonal closure. This will help preserve the structural integrity of the pond embankment.

4. Chemical flocculants such as alum or lime can be added to settling ponds to reduce the length of time needed to settle out solids.

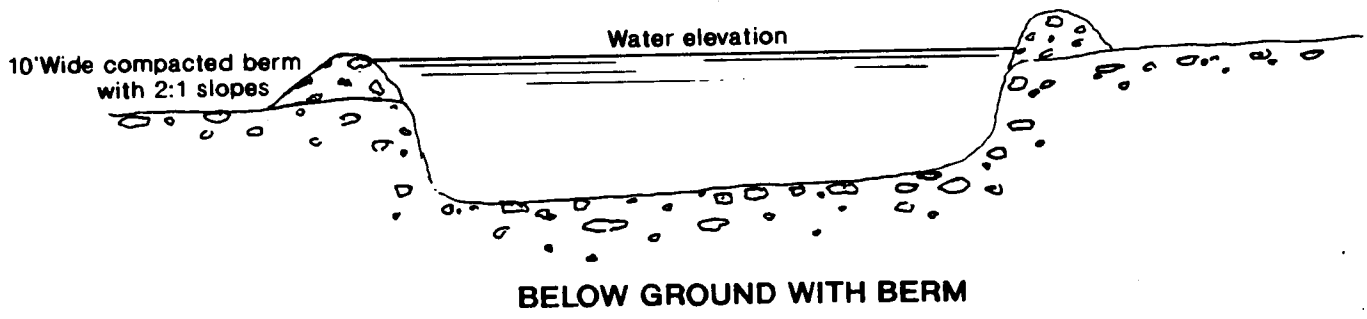
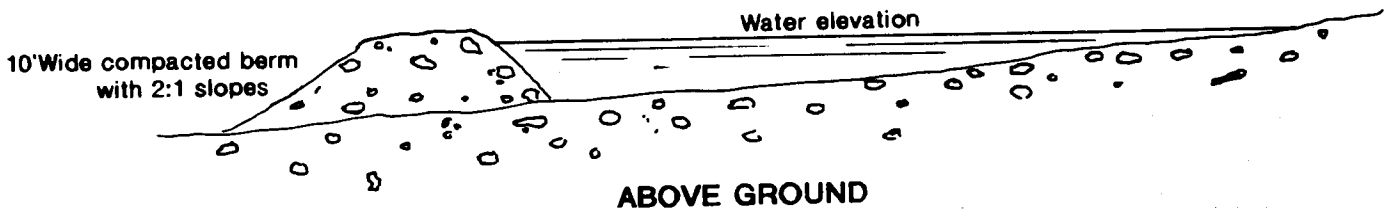
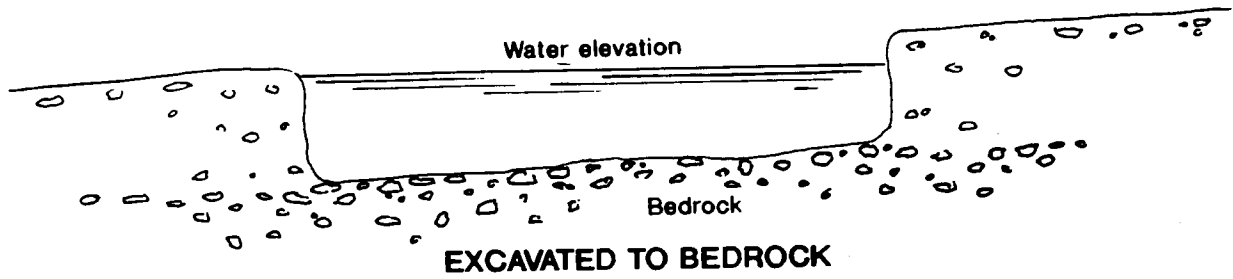
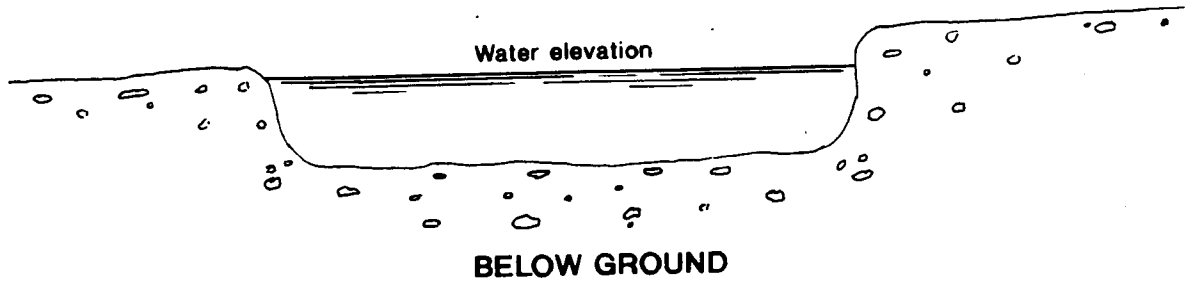

SETTLING POND CONSTRUCTION OPTIONS

FIGURE 5-2

RECLAMATION ALTERNATIVES FOR SETTLING PONDS

If ponds are located in an active flood plain:

1. Dewater the pond onto vegetated ground before commencing additional rehabilitation work. Unless an NPDES permit has been issued, there can be no discharge to surface waters.
2. Remove all sediments away from the floodplain. This can be done with a dragline, front end loader, or trackhoe.
3. Recontour the sides and floor of the pond to blend with the surrounding topography.
4. Seed and fertilize the recontoured area.
5. Another alternative is to complete reasonable stabilization work on the sides of the pond and then leave it intact for fish rearing or wildlife habitat. Seeding and revegetation of the embankment around the pond must be completed to stabilize the area.

If ponds have not been located in an active flood plain:

1. Dewater the pond.
2. Remove some or all of the sediments and stabilize them in an approved area. Recontour the entire site and make the perimeter of the pond irregular by adding fill to some sections while removing it from other areas. Seed, fertilize and mulch the recontoured area.
3. Another alternative is to stabilize the sediments in place by putting a cap of coarse material over the fines to a depth of three (3) feet or more. Then recontour the pond to conform as much as possible to the surrounding topography. Replace topsoil and seed.

Refer to the following BMP's when reclaiming settling ponds:

I.3	Mulch-Straw	II.4	Broadcast Seeding
I.4	Mulch-Wood Chip	II.5	Drill Seeding
		II.6	Vegetative Planting
II.1	Topsoiling	II.8	Fertilizer Use
II.2	Seedbed Preparation	II.9	Maintenance of Revegetated Areas
II.3	General Planting and Seeding		

PROCESS WATER PONDS

Ponds constructed to hold process water, other than that containing cyanide, should be designed by a qualified specialist using current engineering practices and should take into account the criteria outlined under settling ponds. Ponds built to hold process water containing cyanide must be designed in accordance with the guidelines and requirements set forth in **Rules and Regulations for Ore Processing by Cyanidation** administered by the Idaho Department of Health and Welfare - Division of Environmental Quality.

Process water ponds must be designed as a closed system, meaning there is no discharge. The water is recycled for process water after being circulated through the tailings/settling ponds. Process water systems usually contain the following elements:

1. A collection and conveyance system that stores and transports water from the mine/mill to a holding pond.
2. A pump and conveyance system to transport water from the holding pond back to the mine or mill.
3. A conveyance system to transport process contaminated water from the mine or mill to the tailings/settling pond.
4. A pump and conveyance system to carry water from the tailings pond to the holding pond.

Closed circuit process water systems help protect water quality, and make mining/milling possible over a longer season in areas with minimum precipitation. One drawback to these systems is that process water quality can be affected by suspended solids or chemicals that were not removed while the water was held in the tailings/settling pond. Another disadvantage is that where other water supplies are limited, there must be a large, non-mineralized area for pond construction.

EVAPORATION PONDS

Large holding ponds may be used to evaporate water which will alleviate the need to discharge it. Discharge from mines and mills must be collected and conveyed to a large evaporation pond or series of ponds. The system should be large enough so all water can be evaporated, with no discharge occurring. The bottom of the pond should be lined with an impermeable material to prevent seepage into and out of the impoundment. (See Figure 5-2)

SLIME PONDS

Slime ponds are used exclusively in phosphate mining to store phosphatic clay waste. The ponds are created by pumping slime containing 90-98% water and 2-10% suspended solids into an impoundment area behind an earthen dam.

Slime ponds must be designed by a qualified specialist using current engineering practices and should take into account the criteria set forth in this chapter and Chapter 4 - Mill Tailings Impoundments.

RECLAMATION OF SLIME PONDS

Slime ponds are difficult to reclaim because of the high volume of water in the pond, and because a percentage of the suspended solids are so fine (colloidal) they will not settle out. One viable reclamation alternative is to plant deep rooted woody vegetation (varieties of saltbush, quailbush, catclaw acacia, cattails, and leadplant) adjacent to the pond to increase transpiration rates.

Test drilling varies considerably with the type of drilling being conducted, the drilling equipment used, and the depth drilled. These factors directly affect the amount of disturbance. Disturbance is compounded if access roads or drill pads have to be constructed. Shallow seismic drilling leaves only a small diameter hole surrounded by a mound of cuttings, but the line sometimes extends miles in length. Reverse circulation or rotary drills creates similar holes, however, mud holes may be associated with the project. Reclamation is required for the holes, the drill pad, and the access roads.

RECLAMATION REQUIREMENTS

Upon completion of each drill hole, or after the drilling project has been finished, the hole should be filled with cuttings from the bottom to within three feet of the ground surface. Set a concrete plug at the three foot depth and fill the remainder of the hole with cuttings or native soil. If there is an insufficient amount of cuttings to fill the hole, then concrete grout, cement or puddling clay may be used. A small mound of cuttings or topsoil should be left over the hole to allow for settling.

Each drill hole should be properly plugged and abandoned as soon as practical after drilling has been completed and in accordance with specifications outlined by the Department of Water Resources. See Appendix A.

If subsurface water is encountered in a drill hole, puddling clay, cement, or bentonite must be used to seal the water flow, thereby preventing crossflow erosion, waste, and contamination of the ground water.

All cuttings which have been deposited around the hole should be raked or spread out so that growth of natural grasses and foliage will not be impaired.

Access roads, drill pads, and mud pits should be backfilled, recontoured and seeded. Refer to the following BMP's:

I.3	Mulch - Straw	II.2	Seedbed Preparation
I.4	Mulch - Wood Chips	II.3	General Planting and Seeding
I.11	Biotechnical Stabilization	II.4	Broadcast Seeding
III.5	Waterbars	II.5	Drill Seeding
III.10	Rolling Dips	II.8	Fertilizer Use
III.12	Roadway Surface Water Deflectors	II.9	Maintenance of Vegetated Areas

MAINTENANCE

Reseeding efforts should be inspected one growing season after planting to determine additional seeding and fertilizing needs.

TRANSPORTATION, STORAGE, HANDLING, AND DISPOSAL OF HAZARDOUS MATERIALS AND SPILL RESPONSE

The purpose of this chapter is to provide information to prevent petroleum and chemical spills, ensure spills are responded to, or spills are isolated from surface and ground waters of the state. Petroleum and chemicals of concern include, but are not limited to, gasoline, diesel, heating oil, motor oil, rock drill oil, hydraulic fluid, antifreeze, paint, cyanide, mercury, lime, ANFO (ammonium nitrate and fuel oil{explosive}), chlorine, mineral processing compounds, and laboratory supplies. Items discussed are general action and facility guidelines which will reduce the cost and efforts that operators would otherwise incur during compliance with federal and state regulations of non-excluded wastes such as petroleum or chemical contaminated soils. Regulations for cleanup requirements similar to these guidelines are being developed by the Department of Health and Welfare, Division of Environmental Quality.

The United States National Environmental Protection Act and the Idaho Environmental Protection and Health Act authorize regulation for the protection of surface and ground water from contamination by waste materials. Although formal promulgation of regulations is incomplete, procedures and policies for handling petroleum waste exist at both the federal and state levels.

Subjects addressed are petroleum and chemical transportation, storage, handling, and disposal including spill responses and clean up plans, training, communications, safe operating habits, use of proper vehicles, equipment and containers, and use of proper routine collection containment, disposal techniques.

Every operator who transports hazardous materials to and from a mine over public road systems and stores them at the mine site should have a Spill Containment/Response Plan in place prior to commencing operations. The plan should include the following:

- 1) Who to contact if a spill occurs; and
- 2) Methods to contain and cleanup the spill.

Refer to the following publications for additional information: U.S. Department of Transportation Emergency Response Guidebook and the Idaho Hazardous Materials Incident Command and Response Support Plan.

A spill is defined as any discharge of hazardous material, oil, or petroleum products into or adjacent to the water of the State of Idaho that might have potentially harmful effects.

Spills are categorized into two levels:

Level 1 spills are minor events where there has been a discharge of hazardous materials or petroleum products, but where "no imminent hazard to human health and safety or the environment is apparent." Minor spills are classified as less than 55 gallons.

Level 2 spills are major events where there has been a discharge of hazardous materials or petroleum products that exceeds 55 gallons.

Spill Response, Containment and Cleanup Plans – Plans should help minimize contamination of waters and soils, and reduce the time and the financial burden of the operator in complying with state and federal regulations concerning spill management. Prompt implementation of such plans should minimize both environmental and economic impacts of spills.

Spill response, containment, and cleanup plans must:

1. Identify possible contaminations delivered to and used at an operation(s);
2. Provide for a chain of communications within the operation, the community, and to emergency response personnel;
3. Provide for personal safety of employees, the general public, and responders;
4. Provide for site security and isolation from the public and livestock or wildlife, which may spread contamination or impair response efforts;
5. Provide for containment of spilled materials and contaminated soils or water to prevent spreading of contamination by gravity; and
6. Provide for cleaning up and disposal of spilled and/or contaminated materials in accordance with established procedures.

Training -- Training orients employees and the community to the potential safety, health, and environmental hazards of spills. Training will increase efficiency of implementation of spill response, containment, and clean up plans, as well as reduce the routine costs of spills during operations. Training involves providing employees and local communities copies of spill response plans, and maintaining open communication so employees and the local community can assist in response or maintenance at a facility. This training coincides with the required MSHA training.

Training can be done as formally as an operator desires, but should at a minimum be designed to include orientation with the operations spill response and maintenance plans. Formal training is provided by independent contractors who specialize in emergency response and training. Additional information on formal training may be obtained from the Idaho State Police, U.S. Environmental Protection Agency, or the Idaho Department of Health and Welfare, Division of Environmental Quality.

Communications – Communication is important to prevent accidents and spills, implement rapid response to spills, provide for the safety of employees and the general public, categorize severity of spills, as well as provide for proper containment and cleanup. It is important to establish communications between operators, employees, local traffic, local communities, land management agencies, and emergency response agencies during routine operations and emergency situations.

Communication plans should address the following:

1. Employees and operators should discuss potentially hazardous conditions with each other;
2. Communications with CB radios can and should be used to maintain contact with local traffic such as logging trucks and other supply haulers;
3. Communications with local land managers regarding shipping schedules, as well as road and weather conditions may prevent vehicle accidents which result in spills;
4. Should spills occur, employees and the county sheriff should be notified immediately. The sheriff will call the Idaho Emergency Communications Center (208) 327-7422 to implement emergency response, but the operator should notify local authorities to verify the severity of the situation. Information in reports should include:
 - a. Name of Caller,
 - b. Name of Operator or Vendor,
 - c. Type of Injuries Sustained,
 - d. Is Medical Evacuation Necessary,
 - c. Type of Material Spilled,
 - d. Location of Spill,
 - e. Quantity of Spill,
 - f. Proximity to Ground or Surface Water,
 - g. Proximity to population centers or dwellings,
 - h. Immediate Containment, and
 - i. Availability of On-Site Response Equipment; and
5. In some situations the land management agency and Division of Environmental Quality must be notified of the spill by phone within twenty-four (24) hours and in writing within seven (7) days.

Safe Operating Procedures -- Safe operating procedures and maintenance assure quality performance of personnel, equipment, and containment facilities. Guidelines for safe operating procedures include MSHA and OSHA Training manuals, manufacturer equipment manuals, Idaho Department of Transportation and Bureau of Mines publications. Proper performance, operating, and maintenance standards assure reduction of accidents due to equipment failure and operator error:

1. Persons should never perform duties for which they have not been properly trained;
2. Equipment and containers should never be used for functions other than their designed purpose;

Use of Proper Vehicles, Equipment, and Containers – Proper equipment and operating procedures will reduce the number of spills during transportation:

1. Vehicles used for transportation of petroleum and/or other chemicals should always meet with DOT (Department of Transportation) safety requirements. Vehicles should also be equipped with first aid and spill containment equipment, or be piloted by a second vehicle with the first aid and containment equipment.

2. Containers for petroleum and chemicals should also meet DOT requirements and should be specifically designed for that transportation use. Fuels and most chemicals can be delivered in distributors' vehicles, and should never be delivered in fifty-five (55) gallon drums manufactured for lubricants.
3. Spill prevention containment and cleanup equipment is necessary to minimize the effects and costs of petroleum or chemical discharges. Spill response and cleanup equipment or supplies should be material specific, which means they are specifically designed to cleanup the types of materials which may be spilled. Most spill response equipment caches include; two-way radios, first aid kits, absorbent pads, pick axes, shovels, axes, fencing, flagging, plastic sheeting, nylon rope, and emergency lighting.
4. Spill response and cleanup equipment caches should be secured from casual use. Equipment should be readily accessible, however, it should not be used except to cleanup spills. Equipment should be returned to the cache when the cleanup is completed.

Use of Proper Routine Collection, Containment, and Disposal or Recycling Techniques – Proper storage and handling of petroleum and chemicals on site will reduce the need to handle contaminated materials which may impair surface and ground water quality. Proper storage and handling on site will also reduce the amount of time and money spent by operators to comply with state and federal regulations for disposal of regulated wastes. Separation of petroleum and chemicals from surface and ground waters and soil during storage or handling will reduce contaminated waste regulated by state and federal regulations. Separation may be achieved by containment of storage, processing, and maintenance facilities.

1. Proper collection of petroleum and chemical waste -- Petroleum and chemical waste are collected and stored in a segregated manner to avoid unnecessary and secondary handling as prescribed by RCRA Subtitle C Hazardous Waste Regulations. Almost all mining and mineral processing waste may be classified as non-Hazardous Wastes if they are promptly collected and kept separate.
 - a. Drums or other lined containers should be available to separately contain drain oil, parts solvents, wasted antifreeze, drained hydraulic fluid, used oil filters, paint, and sumpage from fuel and storage areas. These materials can be picked up or delivered to recyclers rather than land treating which may affect surface or ground water. Larger volumes of materials such as those from diesel spills may be excavated and land treated in accordance with state procedures and policies (DEQ, 1992).
 - b. Waste petroleum products, chemicals, and contaminated materials should be routinely removed from work areas and spill sites and temporarily stored for proper disposal. Temporary containment facilities should be constructed as lined and bermed areas with contingency plans made to cover such areas to prevent influence by precipitation.
2. Lined and bermed fuel, lubricant, and shop waste storage -- Bermed areas with polysynthetic lining systems can be used to contain supplies and wastes in such a manner as to reduce releases to the environment. Areas which are often bermed and lined include fuel storage, shop, and mill facilities.

Containment areas are constructed of a berm and lining system designed in accordance with the materials to be contained and the size of tanks or containers to be placed inside of the containment area.

a. Bermed areas should be constructed of sufficient height and strength to withstand the force of rapid release from and volume equal to or greater than the largest tank within the enclosure;

b. The base of the enclosure should be sloped such that minor spills and precipitation within the enclosure will collect in a sump;

c. A suitable fine grained material should be bedded on, above, and below lined areas to prevent puncturing of the liner during placement of containers or normal use;

d. A polysynthetic material, clay, or other impermeable liner (depending on the materials to be stored) should be placed over the base and berm, and toed in outside of the berm;

e. The side of an enclosure from which deliveries are made should be protected from heavy equipment so that berms and liners are not damaged from normal traffic;

f. Where several different types of materials are stored, cellular enclosures may be developed by segregating areas with internal berms. Preventing mixtures of different materials such as fuel and antifreeze avoids problems with disposal. Mixed materials are often required by law to be disposed of in certified hazardous waste facilities.

g. Storage facilities should be covered since precipitation may increase the volume of contamination an operator may have to handle; and

h. Storage facilities should be built with a sump. Contaminated water and materials should be removed and disposed of properly.

3. Proper disposal and recycling techniques -- Proper disposal of most mining and processing waste will protect surface and ground water and prevent most regulatory intervention. Several types of waste materials are common at mine sites and they need to be disposed of properly. Drain oils, hydraulic fluids, antifreeze, diesel used to clean parts, other used parts solvents, paint and filters may be handled by recyclers who will visit individual mines or districts to collect such materials. Chemical waste from milling operations and laboratories should be collected and disposed of in certified land fills. Large volume wastes such as soils contaminated from diesel and oil spills can either be incinerated in certified plants or land treated in accordance with specified procedures. The following guidelines should be followed when treating diesel, gasoline or waste oil contaminated soils.

a. Land treatment:

1) The volume of applied Petroleum Contaminated Soil (PCS) may not exceed 1500 cubic yards;

- 2) The PCS may not be applied to properties on which other PCSs have been previously applied;
- 3) The PCS shall not originate from more than three (3) sites, and all sites must be owned by the same entity;
- 4) The responsible party must process a land treatment application request with DEQ;
- 5) Temporary storage areas are defined as areas where materials will be stored for less than sixty (60) days, and should be adequately lined, bermed, and covered;
- 6) Areas must meet minimum site characteristics which include:
 - a) Maximum slope of 12%,
 - b) Minimum distance to surface water of 100 feet,
 - c) Minimum distance to nearest ground water well of 100 feet,
 - d) Minimum distance to nearest buildings to be determined by on-site review,
 - e) Minimum distance to ground water based on site by site characterization, and
 - f) Lands may not include former waste disposal sites, gravel pit, and quarries;
- 7) PCSs should be continually sampled from the period prior to excavation until the material is certified as having been depleted of toxic levels of contaminants;
- 8) Ground and surface water quality near the land treatment site may need to be monitored;
- 9) Air quality permits may also be required. These permits are issued by the Idaho Department of Health and Welfare, Division of Environmental Quality; and
- 10) Accurate and organized records should be maintained throughout the treatment process with respect to:
 - a) Laboratory results from screening and monitoring;
 - b) Soil surveys, soil sampling results, geologic and hydrogeologic conditions, climatic information, topographic maps, distances to surface water, Ground water, ground water wells, residences, etc.;
 - c) Loading rates;
 - d) Treatment operations, schedules, and actual implementation, and
 - e) Accurate plans and specifications.

Section I. BMP'S FOR SOIL STABILIZATION

Contents and Applicability

Best Management Practices (BMP's):

Temporary Treatments:

- I.1 Matting - Plastic.** Plastic matting can be used for dust and erosion control during construction on bare soils. It also aids early vegetative growth by increasing moisture holding capacity of the soil. Plastic net can be used as a temporary or permanent treatment for grass establishment and slope stabilization.
- I.2 Erosion Control Blanket.** A commercially made matting used for erosion control and slope stabilization. It is made of jute or straw and plastic netting.
- I.3 Mulch - Straw.** A temporary mulch which will last from one to two years. The straw will deteriorate without detrimental effects on plant growth or plant establishment.
- I.4 Mulch-Wood Chips.** A temporary mulch of small sized wood chips made from the trunks and branches of trees.
- I.5 Compaction.** A mechanical method of increasing the density of soil to reduce settling and improve resistance to erosion.

Permanent Treatments:

- I.6 Gabions -- Rock-filled wire baskets for use in retaining walls or drainage stabilization.**
- I.7 Riprap -- A permanent rock or aggregate layer placed over the soil to protect against erosion.**
- I.8 Native Rock Retaining Walls -- A low wall made from locally available rock used to stabilize steep slopes.**
- I.9 Timing of Construction and Control Applications -- The sequence of construction activities and erosion control application to minimize erosion created by construction disturbance.**
- I.10 Limited Surface Disturbance -- Limiting the amount of bare soil to the minimum area required to conduct construction activities.**
- I.11 Biotechnical Stabilization -- Biotechnical stabilization involves using live layers of brush imbedded in the ground to control or prevent surficial erosion and mass failure of slopes. Biotechnical stabilization techniques are most effective when shrubs are cut and utilized during their dormant periods.**

BMP'S FOR SOIL STABILIZATION

I.1 Matting - Plastic

Plastic Sheet matting are sheets of polyethylene plastic placed on the soil surface.

Purpose: For temporary erosion control and the protection of sprouted seeds and/or young vegetation. Matting also decreases soil moisture loss and helps hold in heat. Plastic net matting can be used to cover straw mulch as a temporary aide. It can also be used as permanent treatment for establishing grass (without mulching) and for slope stabilization. Plastic sheeting is the most effective matting for retaining moisture in the soil. Its durability depends on the thickness of the sheet. Plastic matting can provide protection from erosion for 6 to 12 months. One disadvantage in using plastic sheeting is that it blocks sunlight and can therefore retard vegetative growth.

Specifications: (See Figure I-1 -- Use similar techniques)

Individual rolls should be laid up and down the slope instead of along the contour. The rolls should be overlapped a minimum of four (4) inches, with the uphill roll overlapping the downhill roll. The edge of the sheeting should be stapled to the ground or buried to prevent movement. When mats are used, it is critical to ensure good contact between the mat and the soil to prevent erosion under the matting. If the sheeting or netting is damaged, it should be replaced immediately.

BMP'S FOR SOIL STABILIZATION

I.2 Erosion Control Blanket

Erosion control blankets are made of jute or straw and plastic netting.

Purpose: Used for slope stabilization, erosion control, and the protection of other mulches from wind and water damage. Jute and straw matting have better erosion control characteristics than straw. Erosion control blanket may be more expensive than using straw mulch secured with nylon, plastic, fabric, wire, or woven paper netting.

Specifications: (See Figure I-1)

Individual rolls should be laid up and down the slope instead of along the contour. The rolls should be overlapped a minimum of three (3) feet with the uphill roll overlapping the downhill roll. The rolls should also be overlapped on each side a minimum of four (4) inches. The matting should be stapled to the ground with staples placed one (1) foot apart. The matting should extend beyond the edge of the mulch, with at least one (1) foot at the sides and three (3) feet at the top. The top edge should be buried in a trench at least eight (8) inches deep. The matting should be laid as smooth as possible.

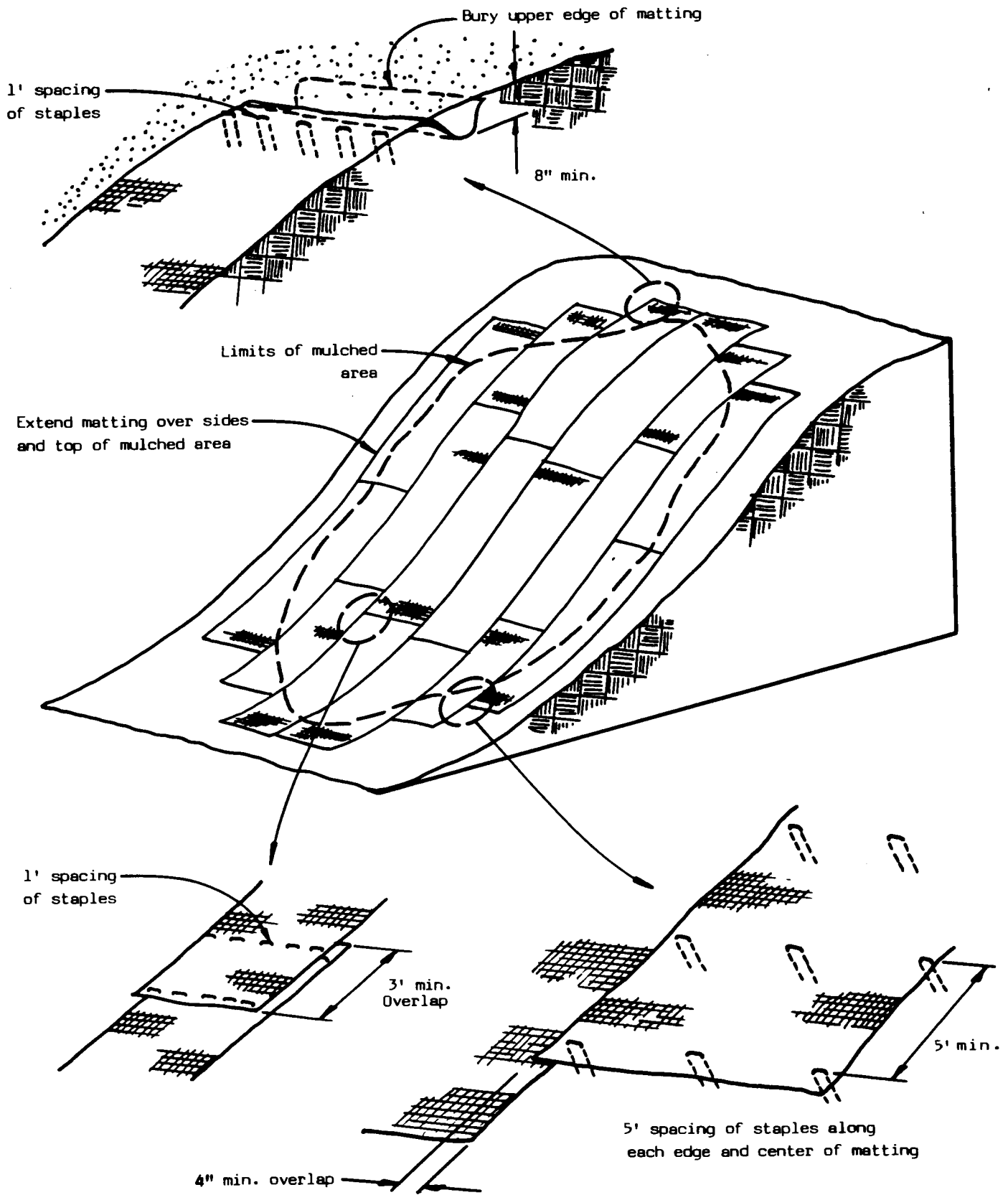

BLANKET INSTALLATION
FIGURE I-1

BMP'S FOR SOIL STABILIZATION

I.3 Mulch-Straw

Mulch-straw should be clean (weed free) wheat, barley, or rice straw.

Purpose: Used as a cover over bare or seeded soil. Mulch helps soil retain moisture and nutrients, it helps reduce soil temperatures, reduces erosion and assists in establishing vegetative growth. Straw mulch can be used on slopes to help prevent wind and water erosion. The mulch however, must be held in place by matting or crimping. Straw mulch held by nylon netting may be used in lieu of jute matting as a cost saving measure. Straw mulch is a reasonably priced, effective erosion control aid. Its effectiveness will decrease with time.

Specifications:

Straw mulch can be hand broadcast or blown on by a mechanical mulcher. It should be applied so there is uniform coverage with a maximum depth of two (2) to three (3) inches (approximately 2 tons per acre). A mulch depth of four (4) inches is acceptable where frost occurs. (Excessive mulching can reduce the nutrient level of the soil) If a deep layer of mulch is used, consider applying a slow release fertilizer to help promote vegetative growth. The mulch can be rolled over with a mechanical device (sheep foot roller), to "punch" it into the ground, or be covered with matting. The mulch can also be covered with nylon, plastic, fabric, wire or woven paper netting held in place by staples. It can also be sprayed with a chemical tackifier such as asphalt emulsion.

BMP'S FOR SOIL STABILIZATION

I.4 Mulch-Wood Chips

Wood chips are made from processing tree trunks and branches in a wood chipper (do not use kiln or air dried lumber).

Purpose: Small sized wood chips are used as a temporary cover over bare or seeded soil to help reduce erosion and assist in reestablishing vegetative growth. Wood chip mulch is a reasonably priced, effective erosion control aid.

Specifications:

Wood chips are hand broadcast or blown by a mechanical mulcher. Chips should be applied so there is uniform coverage to a depth of approximately three (3) inches. The wood chip mulch can be covered with various types of erosion control netting, held in place by staples, or with a chemical tackifier such as asphalt emulsion. Wood chip mulch can be used in lieu of jute and straw matting or straw mulch. Wood chips may cause an imbalance in soil nutrients when they break down, so additional fertilizer (up to 25% more) will need to be applied if wood chips are used as mulch.

BMP'S FOR SOIL STABILIZATION

I.5 Compaction

Compaction is a means of controlling erosion by increasing the soil density which improves its strength and decreases long term soil settlement.

Purpose: **Compaction is useful in stabilizing fill materials.**

Specifications:

Soil compaction is usually accomplished by using a sheep foot roller on clayey soil and a smooth roller on sandy soil. Dozers or heavy equipment can also be used. Care must be taken so the surface soil is not compacted too much, as this will reduce revegetation efforts.

Compaction has a tendency to increase runoff, therefore sediment control structures (as described in Section II) need to be installed below compacted areas. The surface of compacted structures should be scarified, seeded, or seeded and mulched. This will increase the effectiveness of the BMP.

BMP'S FOR SOIL STABILIZATION

I.6 Gabions

Gabions are rectangular wire boxes or baskets, filled with rocks and wired together. They must be assembled in place.

Purpose: They are usually placed on steep slopes as permanent erosion control structures and are particularly useful where water seepage is anticipated. Gabions are also useful for channel stabilization.

Specifications: (See Figure I-6)

Construction specifications should be prepared by professionals familiar with gabion use. The site must be graded prior to installation. Following grading, the wire baskets are placed in position, wired together, and filled with four (4) to eight (8) inch diameter rocks.

Maintenance: The gabion should be periodically inspected for signs of undercutting and instability.

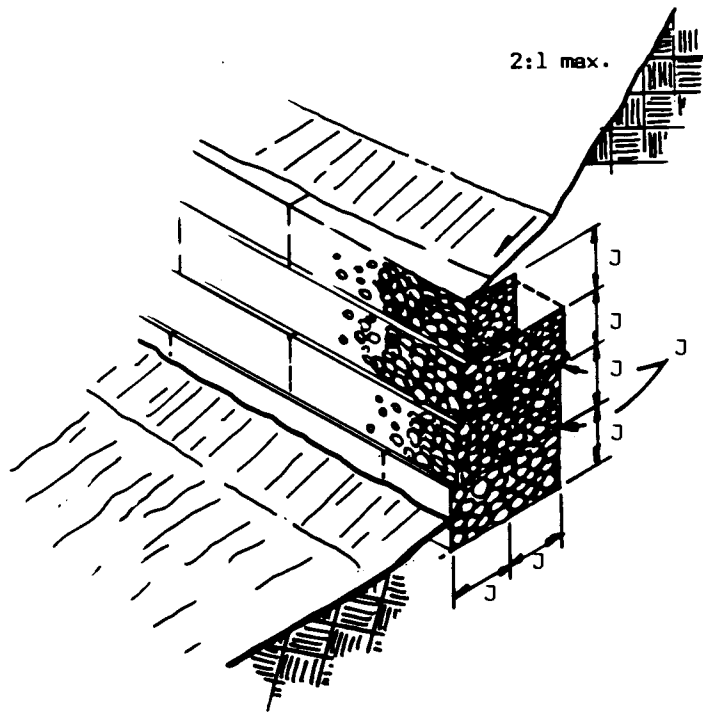

3-DIMENSIONAL

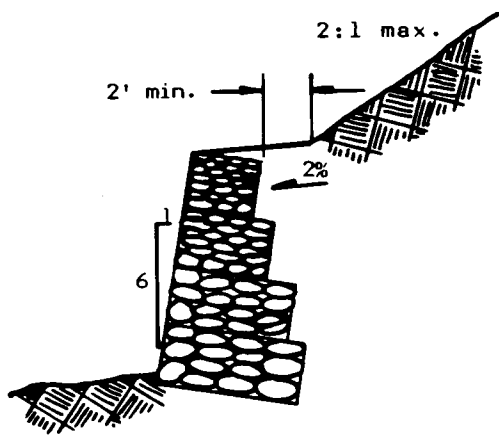

SECTION

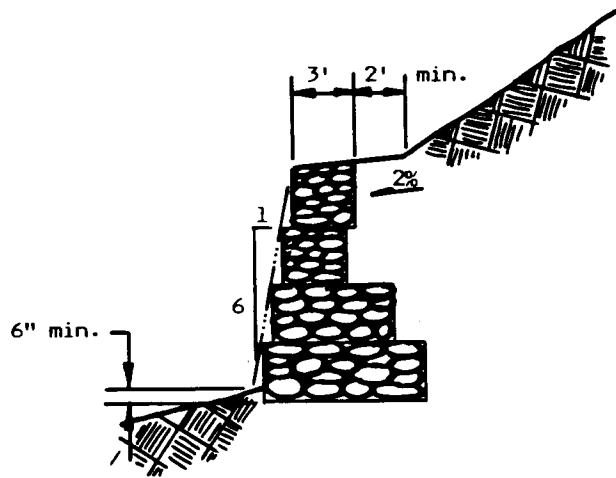

SECTION

BMP'S FOR SOIL STABILIZATION

I.7 Riprap

Riprap is a layer of loose, hard, angular rock placed over soil to help protect against erosion.

Purpose: It is used below culverts, drainage outlets, along shorelines and stream banks, and as a lining in ditches and channels.

Specifications: (See Figure I-7)

A layer of filter material (plastic filter cloth, geotextile fabric, or a layer of sand, gravel or small stones) should be placed between the soil and the riprap to prevent migration of soils through the riprap. Riprap can be installed by hand or with heavy equipment. When installing the riprap, care should be taken so the filter material is not damaged and segregation of the stone size is prevented. A well graded mixture of rocks (well graded mixtures are composed primarily of large stones with an adequate supply of smaller cobbles to fill the voids between the larger rocks) is then placed over the filter material to a depth of six (6) inches or more. When installing riprap in channels, it should be extended from three (3) feet below the water line to a point above the high water mark where vegetation can be established. On a site specific basis, riprap must be properly sized to the maximum flow velocity, to prevent erosion.

Maintenance: Routine inspections should be made on riprapped areas to ensure that the material has not been displaced. Damaged areas should be repaired immediately.

RIP RAPPED DITCH OR CHANNEL
FIGURE I-7

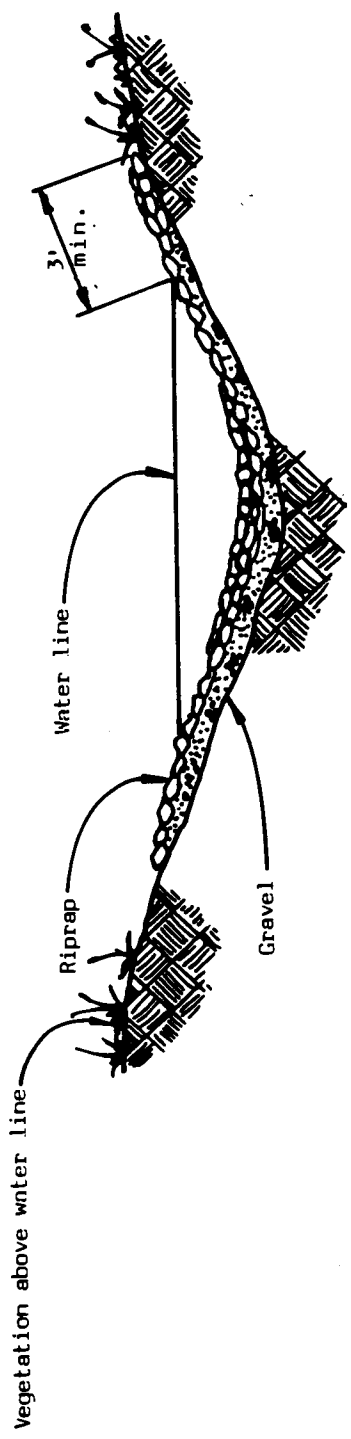

BMP'S FOR SOIL STABILIZATION

I.8 Native Rock Retaining Walls

A native rock retaining wall is a wall constructed of native rocks which provides an aesthetically attractive means for physically stabilizing slopes.

Purpose: Retaining walls are usually constructed on steep slopes which are up to five (5) feet in height and that cannot be effectively regraded or stabilized by another method.

Specifications: (See Figure I-8)

Before installing the retaining wall all large rocks should be removed from the face of the slope where the wall is to be placed. Then a "footing" trench should be put in at the toe of the slope. Large rocks are then placed in this footing trench as indicated in Figure I-8. Arrange additional layers so that each rock above the foundation is securely placed on the ones beneath it. After completing the retaining wall, the footing trench must be backfilled. The slope above the wall should be vegetated, where applicable.

Maintenance: Native rock retaining walls must be inspected periodically and repaired when necessary.

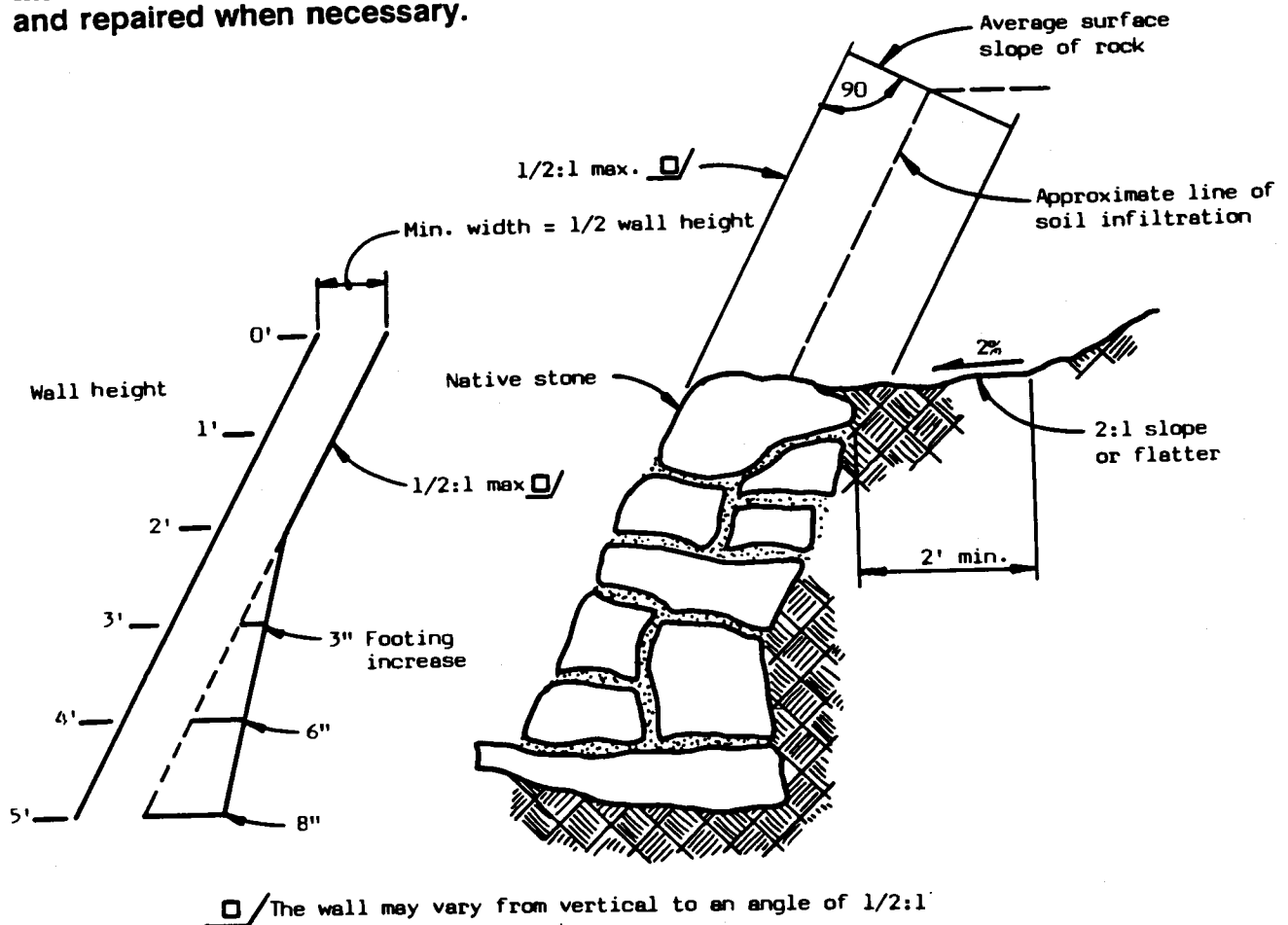

NATIVE ROCK RETAINING WALL

FIGURE I-8

BMP'S FOR SOIL STABILIZATION

I.9 Timing of Construction and Control Applications

The timing of construction and installation of erosion control measures is of utmost importance. Construction should be undertaken during periods when the potential for erosion is at the lowest, i.e. during periods of low seasonal precipitation and runoff. Under all conditions, erosion control measures should be installed in stages to protect work already completed. In highly erodible areas, sediment control measures should be installed before general construction activities commence.

BMP'S FOR SOIL STABILIZATION

I.10 Limited Surface Disturbance

The amount of disturbed land should be kept to a minimum. This will reduce the amount of bare soil exposed to erosion and help control run-off sedimentation. Concurrent reclamation should be carried out as work progresses to help minimize the amount of disturbed soil.

BMP'S FOR SOIL STABILIZATION

I.11 Biotechnical Stabilization

Biotechnical stabilization involves using live layers of brush imbedded in the ground to control or prevent surficial erosion and mass failure of slopes. Biotechnical stabilization techniques are most effective when shrubs are cut and utilized during their dormant periods.

Purpose: Biotechnical stabilization is a cost effective method of controlling erosion on and mass failure of slopes, especially steep cut slopes adjacent to roadways.

Specifications: (See Figure I-11)

- 1. Cut branches and stems (up to three inches in diameter) of willows, alder, or poplar during the dormant season (fall - early spring).**
- 2. Lay the branches and stems atop successive lifts of compacted soil (horizontal terraces cut into the slope) in a criss-cross fashion so the stem will extend the full width of the compacted fill. Branches should protrude from the compacted fill as shown in Figure I-11.**
- 3. Cover criss-crossed branches and stems with a layer of compacted fill.**
- 4. Space brush layers three to five feet apart. Closer Spacing of brush layers might be necessary near the toe of the slope.**
- 5. Continue alternating brush layers with compacted fill as you proceed up the slope from the toe to the top.**
- 6. After a reasonable period of time, roots and shoots will develop. The live vegetation that grows from the cuttings are effective in controlling erosion.**

Maintenance: Once vegetation has been established, maintenance will not be required.

CROSS SECTION VIEW

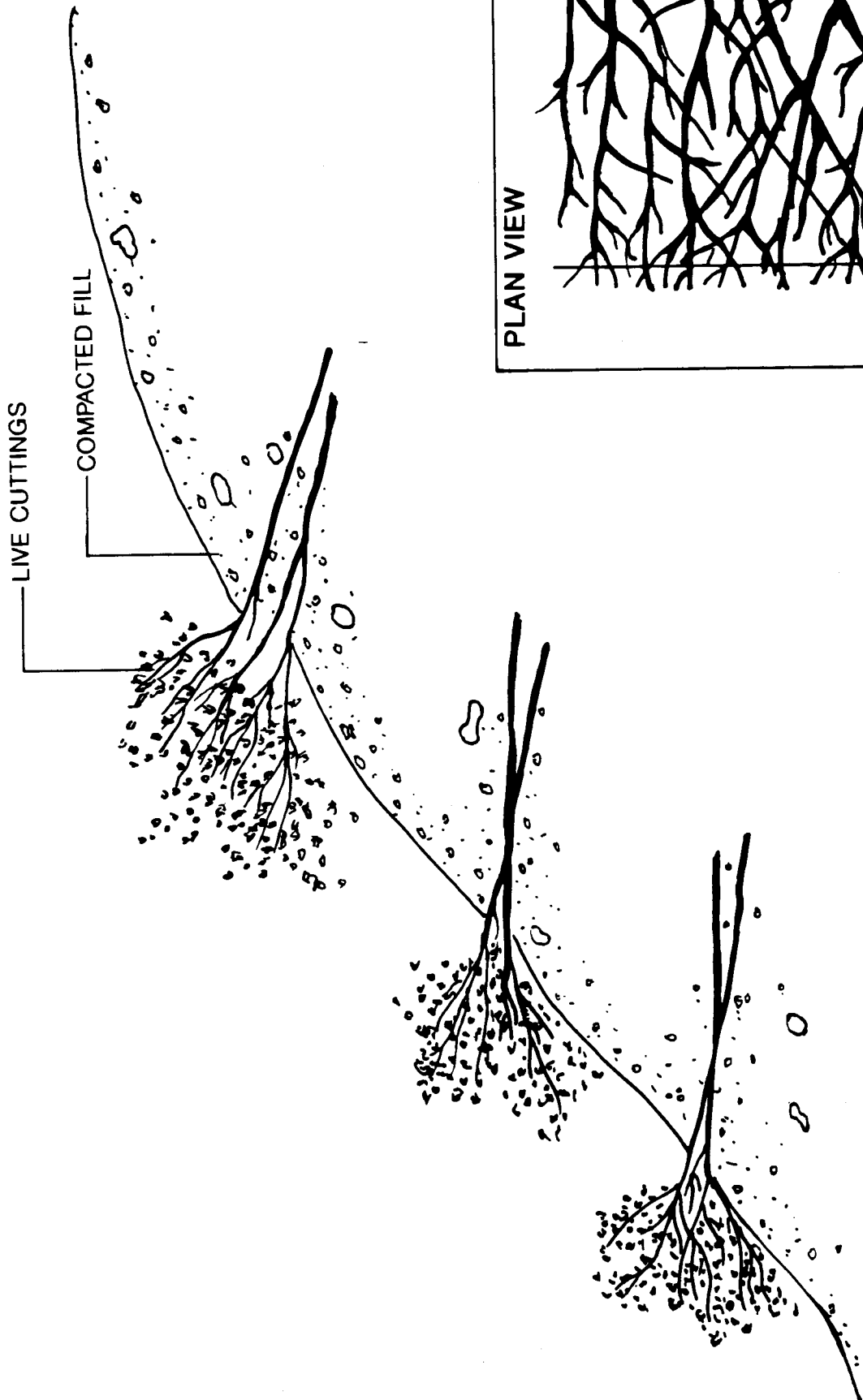

Published 11/16/92

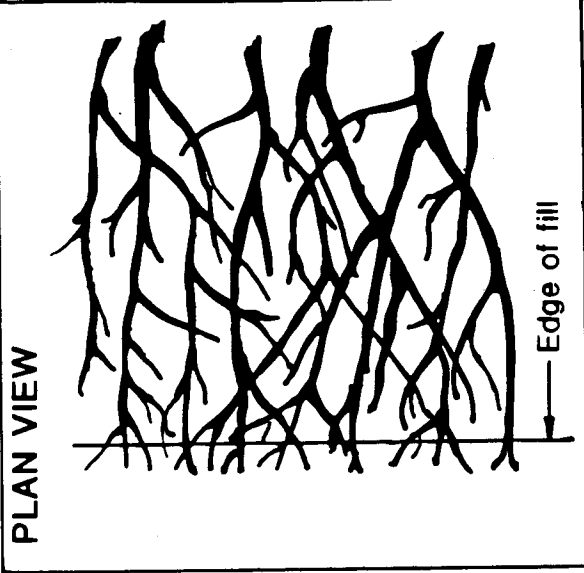

PLAN VIEW

**BIOTECHNICAL STABILIZATION
FIGURE I-11**

Section II:

BMP'S FOR SEEDING & REVEGETATION

Contents and Applicability

Best Management Practices (BMP's):

- II.1 Topsoiling.** Placement of topsoil over a prepared subsoil for the purpose of enhancing revegetation conditions.
- II.2 Seedbed Preparation.** Preparation of the soil surface to provide better plant growth conditions prior to seeding.
- II.3 General Planting and Seeding Specifications.** Information applicable to revegetating disturbed lands.
- II.4 Broadcast Seeding.** Planting seed by scattering seed over the surface of the soil. This seeding method is most useful on small sites, for repairing damage, or for very large, low angle rock areas.
- II.5 Drill Seeding.** Planting seed with an agricultural drill. This seeding method is most useful on large, low angle sites with loose, non-rocky soil.
- II.6 Vegetative Planting.** The method for planting living plants and trees.
- II.7 Willow Cutting Establishment.** The method for selecting and planting willow cuttings.
- II.8 Fertilizer Use.** General guidelines for use of fertilizer. Specific techniques for fertilizer use with revegetation methods using seed or live plants.
- II.9 Maintenance of Revegetated Areas.** Protective measures, irrigation, fencing, fertilization and repair measures for areas being revegetated.

BMP'S FOR SEEDING AND REVEGETATION

II.1 Topsoiling

Topsoiling is the placement of topsoil or other suitable plant growth material over a prepared subsoil.

Purpose: To provide a suitable soil medium for vegetative growth.

Specifications:

The practice is recommended on slopes 2:1 or flatter where the native soil is unsuitable for vegetative growth. Topsoiling may only consist of replacing topsoils that were stripped and stockpiled during initial development activities. Topsoil should be a loam consisting of varying proportions of organic matter, clay, silt, and sand. It should be free of stones, weeds, and inorganic debris. In most mining operations, the top six (6) to twelve (12) inches of soil is stockpiled as topsoil.

Care must be taken when applying topsoil so it is not laid on top of a subsoil of contrasting texture. This could cause the topsoil to slough if water flows between the topsoil and the subsoil.

The following guidelines should be considered when replacing topsoil. However, site specific conditions will have an impact on topsoil availability and application rates.

1. The existing grade of the subsoil should be maintained.
2. Lime may need to be applied to acidic soil to adjust the pH to a more neutral pH of around 7.
3. Topsoil should be uniformly distributed at a minimum compaction depth of two (2) inches (6 to 12 inches is preferred) on slopes graded 3:1 or steeper. It should reach a depth of four (4) inches on slopes flatter than 3:1.
4. Topsoil should not be applied when the subsoil is frozen or extremely wet.
5. The operator should plan on a reduction in soil volume between salvage, stockpiling, and replacement activities. This volume loss could be as much as thirty percent.

BMP'S FOR SEEDING AND REVEGETATION

II.2 Seedbed Preparation

Seedbed preparation entails preparing the soil by ripping, discing, scarifying, and adding soil amendments to make the soil more productive and enhance revegetation efforts.

Purpose: To promote successful revegetation efforts by preparing the soil for planting and creating proper seedbed conditions.

Specifications:

Seed bed preparation is applicable for all sites to be revegetated by seeding. Seed germination and seedling establishment are enhanced by loosening the surface of the soil by hand or machine raking prior to planting and then covering the seeds by raking or scarifying the soil to a depth of 1/4 to 1/2 inch. Good seed germination and establishment is also obtained by seeding on one (1) to six (6) inches of snow.

Seedbed preparation including weed control and soil tillage are essential for successful sowing and the establishment of seedlings. Weeds must be controlled by mechanical means or by spraying.

Good seedbed preparation may be difficult to achieve. Areas to be seeded should be ripped or scarified, to a minimum depth of three (3) inches. The soil should be worked to establish suitable conditions in which the seeding equipment can be operated. Areas to be seeded by broadcasting should be tilled immediately before seeding to a depth of two (2) inches, except on benches where no additional preparation is necessary or possible.

Seeding areas can be separated into the following types:

1. Rocky areas which are untillable.
2. Benched areas need no preparation as sloughing of soil from the bench above will tend to cover seeds.
3. Very steep areas (steeper than 2:1, a 50% slope, a 27° slope) are extremely difficult to seed. Hydro seeding or broadcast seeding should be used at these sites. Dragging a cleated cat track across slope will do a satisfactory job in loosening the soil.
4. Steep areas (between 2:1 and 3:1, between a 50% and a 33% slope, or between a 27° and a 18° slope) can be cat-walked up and down in most soils. This leaves a good seedbed by firming the loose soils and loosening the hard soils. This work should be completed immediately prior to seed application. Note: Rough, loose seedbeds on all steep slopes is important to help retain water, nutrients, and promote infiltration. Roughened seedbeds also help enhance hydroseeding efforts.

BMP'S FOR SEEDING AND REVEGETATION

- 5. Sloped areas (3:1 or flatter, less than a 33% slope, less than a 18° slope) can be prepared with conventional equipment such as discs, harrows, or rippers and a grader. Slopes that exceed 10° should be prepared with cleated equipment such as a sheep foot roller. Fill slopes, flatter than 3:1 may not need to be prepared before seeding, however, they should be checked for satisfactory seedbed conditions.**

BMP'S FOR SEEDING AND REVEGETATION

II.3 General Planting and Seeding Specifications

These are general guidelines that apply to all planting and seeding operations. They are designed to enhance the success of revegetation efforts. These guidelines are applicable to most revegetation and landscaping work.

The Soil Conservation Service (SCS) is a good source of information on seed and planting specifications in addition to Appendix D.

Seeding and Planting Guidelines:

1. Annual grasses and legumes are recommended for quick cover, rapid temporary soil protection, or as a nurse crop combined with slower growing perennials. Perennial grasses and legumes, shrubs and trees are for continual soil protection.
2. All grasses, legumes, shrubs, and trees used in revegetation should be certified as viable and be effective for erosion control and soil stabilization.
3. Most legumes should be inoculated with appropriate bacteria before seeding since many varieties will not germinate without being inoculated.
4. Trees and shrubs can be used to provide lasting vegetative stabilization and should protect the soil surface after the grasses and legumes decline. Trees and shrubs, however, may not survive in all climates, and species selection for reclamation should be based on site specific conditions. See appendix D.
5. Trees, shrubs, and grasses, used in revegetation, should be of a similar species to that existing prior to mining. This will assist in maintaining the biological integrity of the area being reclaimed.

Site Evaluation and Modification of Revegetation Methods:

1. Existing soil survey reports should be consulted for each revegetation site or area. All sites should be inspected and/or tested by a soil scientist for texture, organic matter content, drainage, slope, and aspect. Testing for potentially toxic elements, water holding capacity, and nutrient levels should be done by a soils lab.
2. When the pH of the soil is less than 5.5 (acidic soil), seedling establishment may be limited. Lime can be added to increase the soil pH to a more neutral pH of 7. Lime should be applied at a rate determined by soil testing and it should be tilled into the top four (4) to six (6) inches of soil. Powdered lime or waste treatment lime can be used.

BMP'S FOR SEEDING AND REVEGETATION

3. When the frost heave potential of the site is determined to be high to moderate, the following precautions should be taken:
 - a. Planting and seeding should be conducted from May 1 to August 1. Supplemental irrigation will be required in this case for germination and seedling establishment.
 - b. Mulch rates should be increased 50 percent over those specified in chapter 1, to 3 tons of straw per acre.
 - c. Areas damaged by frost heaving (after the initial seeding season) should be repaired to original specifications, if possible. The mulch rate on the repaired area should be 50 percent greater than the original application rate.
 - d. Follow-up application of fertilizer should be made each spring for the first two (2) years following the initial seeding to help plants establish and maintain vigorous growth and develop extensive root systems which will help to stabilize the soil.

Some seeds require pretreatment prior to planting. Check with seed suppliers to ascertain the need for and/or acquire treated seed. Shrubs and trees may be seeded or planted from bare root or potted stock. Cuttings from some species can also be taken from native stock adjacent to the area and planted in moist ground. Bare root shrubs and trees should be kept bundled and in cold storage prior to receipt and before planting. Potted trees and shrubs should be stored in the shade, outdoors, and should be sprinkled periodically with water to keep the soil moist.

Season of Seeding:

Selection of the proper season for seeding is vital in ensure successful revegetation. Even if all other conditions are satisfactory, if the timing of the seeding is poor, the seedlings are likely to die. Seeding in the fall is preferable. Early spring seeding is also acceptable.

Fall seeding is most successful in Idaho. Field experience has shown that seeding on one (1) to six (6) inches of snow over freshly scarified soil produces excellent germination. Spring seeding is most successful on northern facing exposures. Generally, the greatest potential for seeding failure is from freezing of the young plants prior to establishment.

When seeding in the spring, moisture conditions may not be adequate for establishment. In this case, the seedlings may not survive dry summer weather.

BMP'S FOR SEEDING AND REVEGETATION

II.4 Broadcast Seeding

Broadcast seeding is the process of uniformly casting seeds and fertilizer on the soil by hand or mechanical means.

Purpose: Broadcast seeding is employed when seeding grasses, shrubs, forbes, or trees on flat surfaces and slopes where other seeding methods are not appropriate. Broadcast seeding is well suited for use on steep slopes, rocky areas, abandoned roadways, sites with limited access, and where hand labor is used.

Specifications:

The following procedures are recommended for the most successful application and growth. These procedures should be followed only after the seedbed has been prepared:

1. Apply fertilizer and work it into the soil. Fertilizer can also be applied either at the same time or after the seeds have been broadcast. Check the soil analysis for fertilizer application rate.
2. Apply seed by either wet (hydroseeding) or dry broadcasting. Seeds placed in a hydroseeder should be used within 30 minutes of having been put in water. In general, broadcast seeding rates must be twice the drill seeding rate.
3. Where applicable and if mulch is not going to be applied, lightly rake over the broadcast seed. The soil cover will help protect the seed and facilitate germination. Seeds covered with 1/4 to 1/2 inch of soil will have a better germination rate than those left on the surface of the ground.
4. Apply mulch, when necessary, either by hand or with a mechanical mulcher.
5. On steep slopes that are inaccessible, and where other methods are impractical, seeding should be done with a hydromulcher or by broadcasting.

BMP'S FOR SEEDING AND REVEGETATION

II.5 Drill Seeding

Drill seeding is the process of planting seed and fertilizer using an agricultural or rangeland drill seeder.

Purpose: This method is most effective on flat, non-rocky surfaces. Drill seeding provides the maximum possibility for successful germination and growth, with a minimum investment in fertilizer, seed, and labor because seeds are not damaged or carried away by wind, water, animals, or birds.

Specifications:

The following procedures are recommended for the most successful application and growth rate:

1. The soil must be loose enough to allow penetration of the drill disc to a depth of approximately two (2) inches. This will help ensure that seeds are not planted too deep or left on the surface of the ground.
2. Fertilizer should be applied at specified rates after soil analysis at an appropriate soil laboratory.
3. On steep slopes where drilling equipment cannot be used, broadcast seeding methods should be utilized.

BMP'S FOR SEEDING AND REVEGETATION

II.6 Vegetative Planting

Vegetative planting means the establishment of vegetation by planting trees and shrubs from nursery stock or transplants.

Purpose: Planting vegetation is an effective means of promoting soil stability and controlling erosion; however, until establishment is complete the site is vulnerable to erosion. Trees and shrubs should be planted in conjunction with grasses and legumes to enhance the overall effectiveness of soil stabilization efforts and erosion control measures.

Specifications: (See Figure II-6)

The following procedures are recommended for the most successful establishment of vegetation:

1. Choose plant species native to the area and that match specific habitats. The type of vegetation planted may be dependent on the intended use of the site following reclamation. In this case, native vegetation might not be the preferred alternative.
2. Planting holes should be prepared as shown in Figure II-6. Seedlings should be placed in the hole so the crown of the plant is at the surface of the soil. The roots should not be folded and there should be no air space around the roots.
3. Planting should be supervised by someone skilled in revegetative techniques.
4. Fertilizer should be applied as specified by the manufacturer or in accordance with soil testing results.
5. The survival rate of vegetation will be increased if plants are irrigated regularly during the first two (2) years after planting.

Maintenance: Adequate maintenance following planting is absolutely essential for maximum success of the revegetative efforts. Fencing may be required to protect planted areas where there is livestock grazing or wildlife use.

BMP'S FOR SEEDING AND REVEGETATION

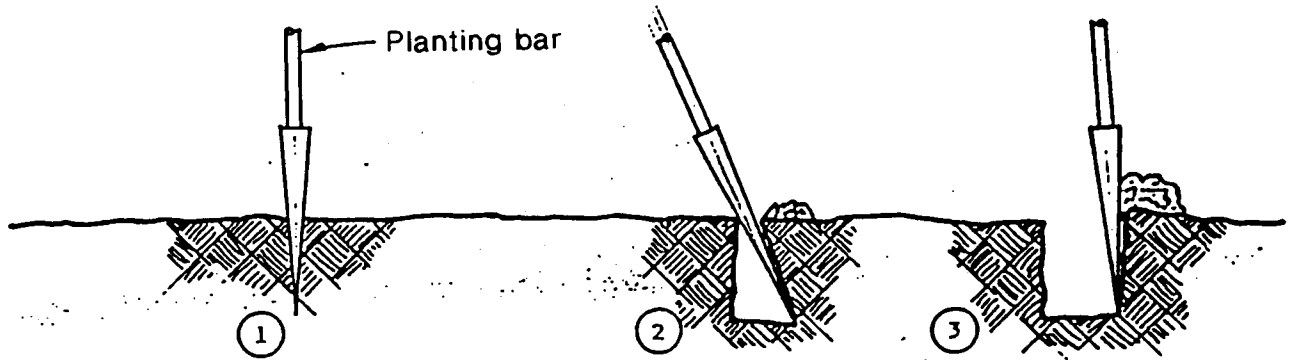

PREPARATION OF PLANTING HOLE USING PLANTING BAR

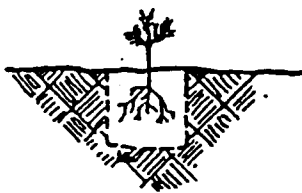

CORRECTLY PLANTED

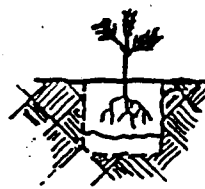

Air
space



Roots
folded



Too
deep

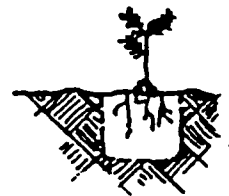

Too
shallow

INCORRECTLY PLANTED

11.7 Willow Cutting Establishment

Willow cutting establishment is the process of selecting and planting willow cuttings to help stabilize streambanks. Planting willow can also enhance fish and wildlife habitat.

Purpose: To stabilize streambanks and other reclaimed areas adjacent to water.

Specifications:

Planting of willow cuttings is recommended when completing streambank stabilization efforts or in areas adjacent to water where there is enough moisture for cuttings to take hold and grow.

The guidelines listed below should be followed when selecting and planting willow cuttings:

- 1. Select varieties that are indigenous to the area in which you wish to re-establish willows. Select varieties compatible with your objective and the stream size, i.e. shrubby types for outside curves, tree types for shade areas, small varieties for small streams.**
- 2. Cuttings should have smooth bark and should come from willow stock two years or older.**
- 3. Make cuttings at joint or at ground level so the natural appearance of the parent plant is preserved. Trim back root end to a diagonal cut, approximately one-half inch below a leaf node.**
- 4. Cover top of cutting with pruning seal or latex paint immediately after cutting. This will help prevent damaging the cuttings and ensure they are oriented correctly when planted. Remove all leaves and side branches and keep at least the bottom one-third of the cutting emersed in water. If cuttings must be stored for more than a week, wrap bundled cuttings with burlap and store in a cool place. Soak stored cuttings in water for 24 hours before planting.**
- 5. Cuttings must be planted in soil that will remain moist during the growing season. Cuttings need to be anchored or protected against erosion until established. Do not leave air pockets around cuttings.**
- 6. Cuttings should be long enough so one or two bud nodes are in permanent contact with moisture. Three to four bud nodes should be above ground.**

BMP'S FOR SEEDING AND REVEGETATION

- 7. Plant shrubby type willows one - three feet apart. Plant in a random pattern. Avoid planting in rows. Cuttings can be planted in shallow trenches along stream banks. They can also be anchored in holes excavated below the scour line (scour - to clear, dig or remove by a powerful current of water) in the channel bottom adjacent to the bank.**

For more detailed information on willow planting, contact the Aberdeen Plant Material Center, Aberdeen, Idaho, or the Idaho Department of Water Resources.

II.8 Fertilizer Use

The following guidelines can be used to select fertilizer types. The guidelines will help prevent improper or excessive use of fertilizer that may result in water quality impacts or damage vegetation. The techniques are applicable to all revegetation efforts.

Purpose: Fertilizer(s) should only be used when soils are deficient in nutrients which retard or impair vegetative growth. The use of fertilizer will promote revegetation efforts if the proper type and amounts are applied.

Specifications:

The following guidelines pertain to types of fertilizer:

1. **Slow release fertilizer.** This type of fertilizer is one of the most reliable methods of providing nutrients for plants. It is best adapted to application during seeding, vegetative planting and maintenance of established vegetation. Recommended application rates are usually specified on the fertilizer container.
2. **Fast release fertilizer.** This type of fertilizer releases nutrients rapidly, making them available for immediate use by plants, which makes it most adaptable to maintenance operations after vegetation has been established. When fast release fertilizer is applied at the same time as seeds, nutrients can be leached out of the ground before the seeds germinate. Application rates are usually specified on the fertilizer container. If fast release fertilizer is needed, choose a type that contains nitrogen, phosphorus, and sulfur. Nitrogen maintains plant growth and phosphorus aids in root establishment and initial plant growth. Sulfur should be included in the fertilizer as some soils are deficient in this nutrient.
3. **If fertilizer is applied at the recommended rate and fails to promote or increase vegetative growth over that which would occur naturally, do not apply more fertilizer. Instead, have the soil tested and follow the recommendations of the test report.**
4. **Excessive or incorrect use of fertilizer can cause more harm than good. For example, excessive nitrogen can kill seedlings, particularly in dry areas. Fertilizer should be applied, by broadcast methods, after seeding has been completed. Operations which apply fertilizer, usually apply between four hundred (400) and one thousand (1000) pounds per acre. Note: Fertilizer type and application rate should be based on soil tests.**

BMP'S FOR SEEDING AND REVEGETATION

II.9 Maintenance of Revegetated Areas

Maintenance can include, but is not limited to, irrigating, fencing, fertilizing, and repairing revegetated areas to help ensure the success of revegetation efforts. These measures should be applied to sites revegetated within the past one (1) to five (5) years.

1. **Irrigation:** Provisions for irrigation, especially on dry lands, should be included in the initial reclamation plan. On areas that will require irrigation to ensure that the plants or seeds do not die, the following measures should be taken:
 - a) **Keep the soil moist from planting time until the seeds germinate.**
 - b) **Water frequently during the growing season so that the soil retains enough moisture to ensure plant growth. Try to coordinate irrigation with natural precipitation so the site is not over-watered.**
 - c) **During the second growing season, after plants are established, the frequency of watering can be reduced. This will help plants become accustomed to natural conditions but it will provide sufficient water for growth during the season.**
2. **Fencing:** All revegetated areas that are potentially subject to heavy use by either livestock or wildlife before the plants have become established, should be fenced to ensure adequate regeneration.
3. **Fertilizing:** In some instances it is beneficial to apply fertilizer after the first growing season to help ensure and enhance revegetative efforts. Site specific conditions and soil testing should dictate whether fertilizer should be applied and at what application rates.
4. **Repairs:** Repairs could include reseeding, repairing damage caused by wind and water erosion or damages caused by animals and man. All damage should be repaired as soon as possible after it occurs. Site specific conditions will dictate what repairs are necessary.

Section III: BMP'S FOR RUNOFF COLLECTION

Contents and Applicability

Best Management Practices (BMP's):

- III.1 Diversion Dike/Ditch.** Diversion dikes/ditches should be used whenever it is necessary to dispose of concentrated surface water without causing erosion. Diversions should be used in conjunction with a silt fence or sediment ponds.
- III.2 Interceptor Trench.** Used to interrupt long slope faces on gentle slopes (less than 3:1) and to allow diversion and infiltration of collected runoff and retention of sediment.
- III.3 Open Top Box Culverts.** A temporary or permanent drainage collection system. Should be used in conjunction with a silt fence and riprap.
- III.4 Siltation Berm.** A temporary impermeable berm for use on construction sites to retain runoff water on site.
- III.5 Waterbars.** A berm constructed across the roadway to divert storm runoff away from unpaved surfaces or other disturbed areas.
- III.6 Culverts.** Corrugated metal pipes used for runoff collection and conveyance.
- III.7 Drain Fields.** A drainage system constructed of rock or rock and perforated pipe, used to drain water away from construction sites.
- III.8 Stream Alteration.** The diversion of a stream into a new channel, pipe, or culvert.
- III.9 Drop Structures.** Natural materials such as rocks and trees that are put in streams for stabilization, controlling water velocities, and creating fish habitat.
- III.10 Rolling Dips.** Structures that are designed into a road surface when it is being surveyed that are intended to divert water off the road surface. Rolling dips are the result of gradual grade changes along a length of road.
- III.11 Road Sloping.** Selectively constructing or grading a road surface to direct surface water runoff in a desired direction, usually to the outside of the road.
- III.12 Roadway Surface Water Deflectors.** A roadway surface water deflector is a runoff interceptor built of treated wood and conveyor belt. The deflector is installed across the roadbed to convey surface water off the roadbed.

BMP'S FOR RUNOFF COLLECTION

III.1 Diversion Dike/Ditch

A diversion dike/ditch is a runoff interceptor built to divert surface water away from un-vegetated areas on to adjacent vegetated ground. Diversions are also used to divert creeks or streams away from mine areas.

Purpose: Diversion dikes should be used to route surface waters around structures such as tailings impoundments, settling ponds, or any other mine facility.

Specifications: (See Figure III-1 and III-2)

1. Height: 1.5 feet or greater.
2. Width at top: two (2) feet minimum.
3. Side slope of dike: 2:1 or flatter.
4. Compaction: should be adequate to ensure a stable dike that will not erode or wash out easily.
5. Grade: for grades in excess of 2% or where large flows are anticipated the diversion channel may need to be mechanically stabilized with a concrete or riprap lining.

The diversion dike consists of a trench and dike. The trench can be constructed by using either heavy equipment or hand tools. The bottom and sides of the ditch should be riprapped with rocks or lined with a geotextile fabric. This will help stabilize the sides of the ditch and reduce sediment loading in the water caused by the bare ditch banks. Dike banks above the water line should be seeded.

Diversion dikes should be designed large enough to carry normal runoff volumes, as well as additional water from a major storm event.

Maintenance: Diversion dikes should be inspected regularly and repaired if damaged.

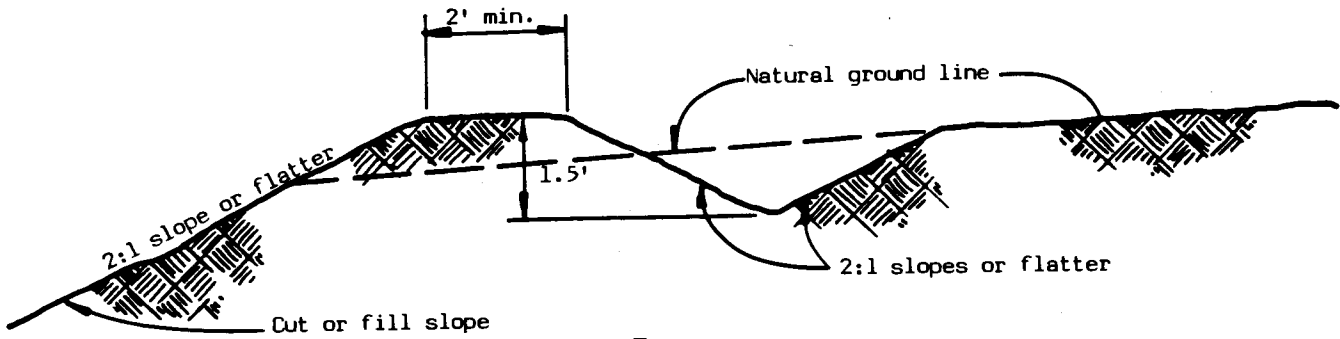

NOTE: Bed of dike to be riprapped.

SECTION

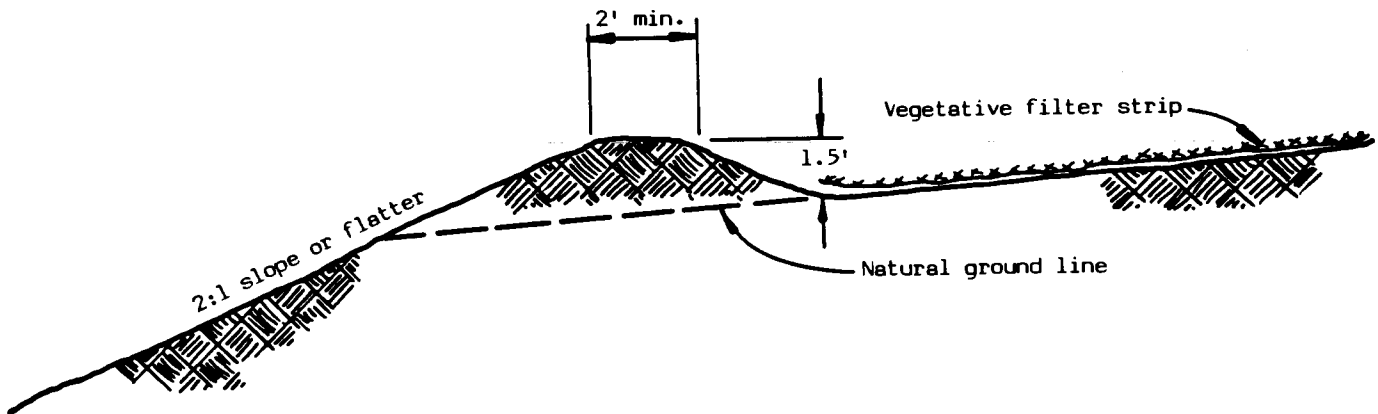

- NOTES: 1) Dike constructed by dozer moving soil upslope and dumping at top of slope.
 2) Outlet to stabilized vegetated soil.

SECTION

BMP'S FOR RUNOFF COLLECTION

III.2 Interceptor Trench

An interceptor trench is a trench built along the contour of a slope to store and/or divert surface runoff. An interceptor trench is smaller and less permanent than a diversion dike/ditch. In addition, it is designed to carry surface runoff only, not streams.

Purpose: Interceptor trenches can be used to divert water around mining structures such as stockpiles, waste dumps, pits, settling ponds, or tailings impoundments. Interceptor trenches are effective on gentle slopes (3:1 or less) with long, uninterrupted expanses.

Specifications: (See Figure III-1, III-2)

Locate and construct the interceptor trench so that it lies along the contour of the slope and can discharge onto stable, preferably vegetated, ground. The trench should be large enough to carry normal volumes of water as well as additional precipitation from a major storm event. Excess material should be cast on the downhill side of the trench. The trench banks (above the water line) and adjacent disturbed ground should be seeded immediately after construction is completed. The slope of the trench must not exceed two (2) percent in order to prevent erosion of the trench.

1. Depth of trench: twelve (12) inches minimum at downslope side.
2. Width at bottom of trench: eighteen (18) inches minimum.
3. Slope of sides of trench: 2:1 or flatter.

The bottom of the trench should be riprapped with rocks or lined with a geotextile fabric. This will help reduce sediment load in the water caused by the eroding of the ditch banks.

Maintenance: Interceptor trenches should be inspected regularly and repaired if damaged.

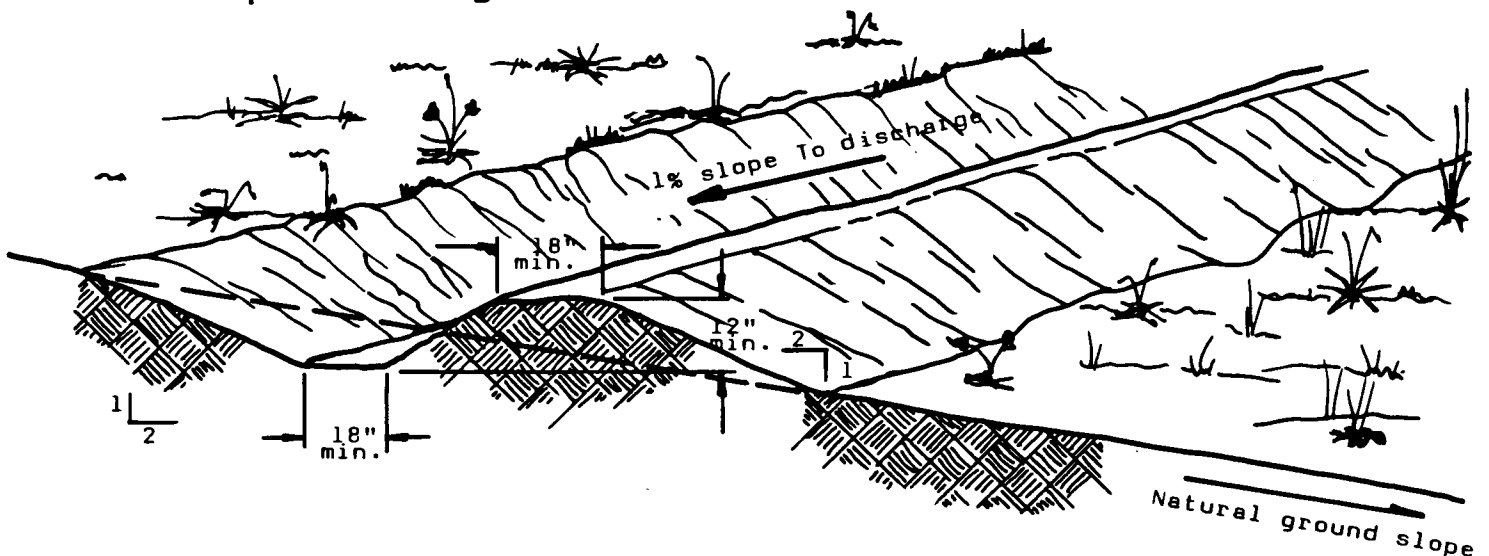

INTERCEPTOR TRENCH

FIGURE III-2

BMP'S FOR RUNOFF COLLECTION

III.3 Open Top Box Culverts

An open top box culvert is a wooden culvert installed across the roadbed to convey surface runoff and flow from inside ditches onto the downhill slope of the road.

Purpose: The open top box culvert can be installed on lightly used, unpaved roads with steep grades (greater than 6%). This type of culvert can be used as a substitute for pipe culverts.

Specifications: (See Figure III-3)

Box culverts can be constructed with logs, lumber, guardrails, or corrugated steel. They consist of open-top, three-sided, box-like frames installed flush with the road surface and angled downward across the roadway. The inflow end should be at the same grade as the side ditches on the road and should extend into the cut bank. The discharge end should extend six (6) to twelve (12) inches beyond the surface of the roadbed and should be directed onto vegetated ground, riprap or into another erosion control structure such as a sediment trap or catch basin.

Maintenance: Open top box culverts should be inspected, cleaned, and repaired on a regular basis as needed.

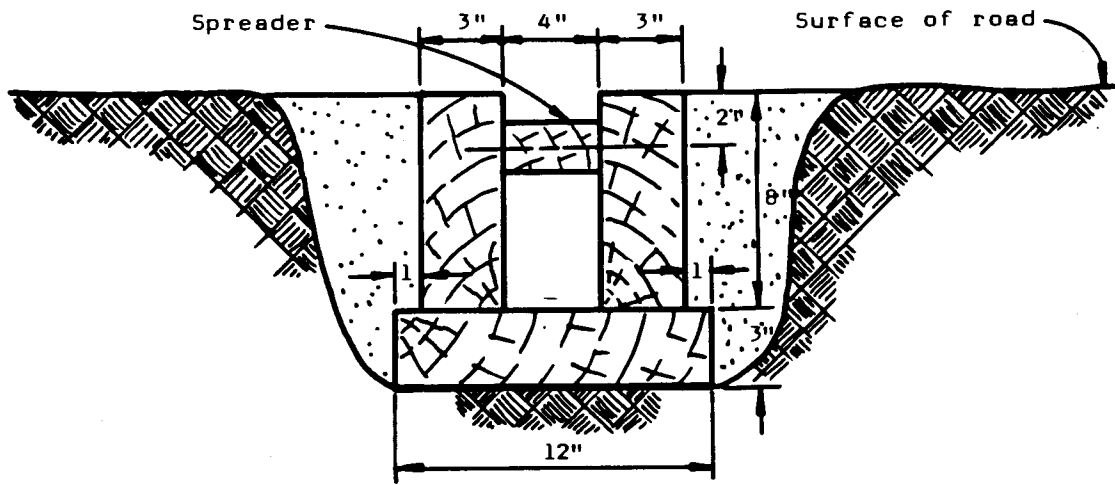

END VIEW

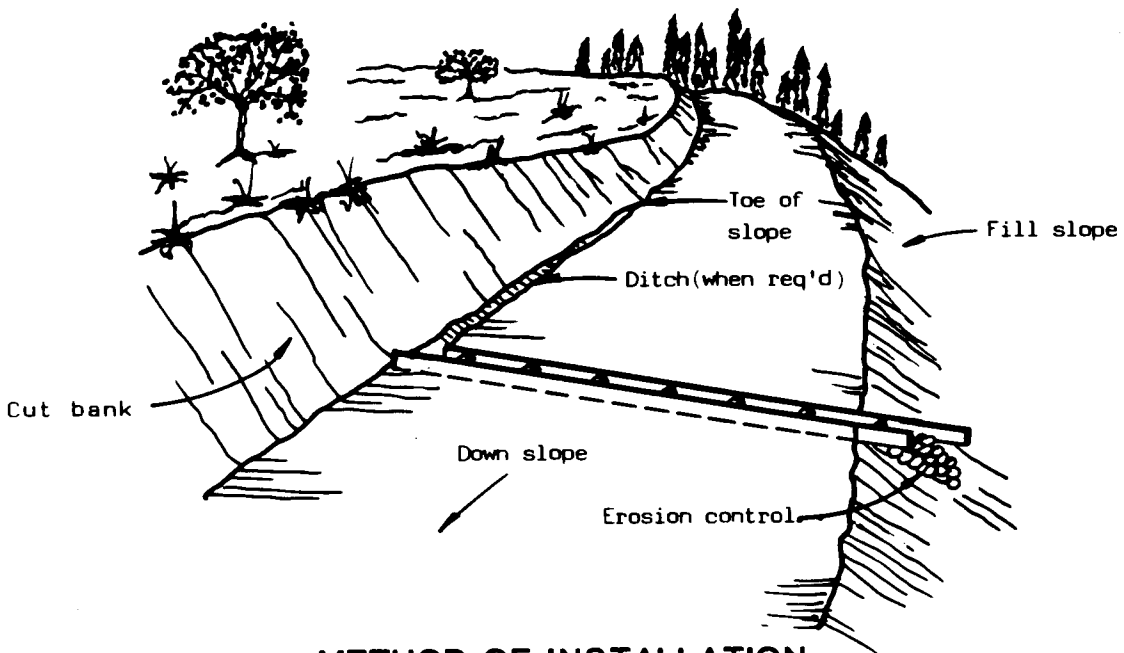

METHOD OF INSTALLATION

BMP'S FOR RUNOFF COLLECTION

III.4 Siltation Berm

A siltation berm is an impermeable barrier placed around a disturbed site to capture and contain surface runoff so that sediment can be filtered prior to discharging the water. Siltation berms should be placed on the downslope side of the disturbed ground.

Specifications (See Figure III-4)

1. Berms should be large enough to control runoff water from a major storm event.
2. The berm should be constructed of the following materials:
 - a) 3/4 to 1 1/2 inch gravel, or other, similar coarse material;
 - b) plastic sheeting, at least six millimeters thick, and wide enough to cover the berm and allow a two foot overlap on each side of the berm.
3. The berm should be located along the contour of the slope at the downhill boundary of the disturbed ground.
4. Gravel or another coarse material should be mounded into a ridge, with a slope not to exceed 2:1, of sufficient height to contain runoff water from a design storm event.
5. Plastic sheeting should be placed over the berm and anchored down as indicated in Figure III-4.

Maintenance: Siltation berms should be inspected regularly and repaired immediately when damaged.

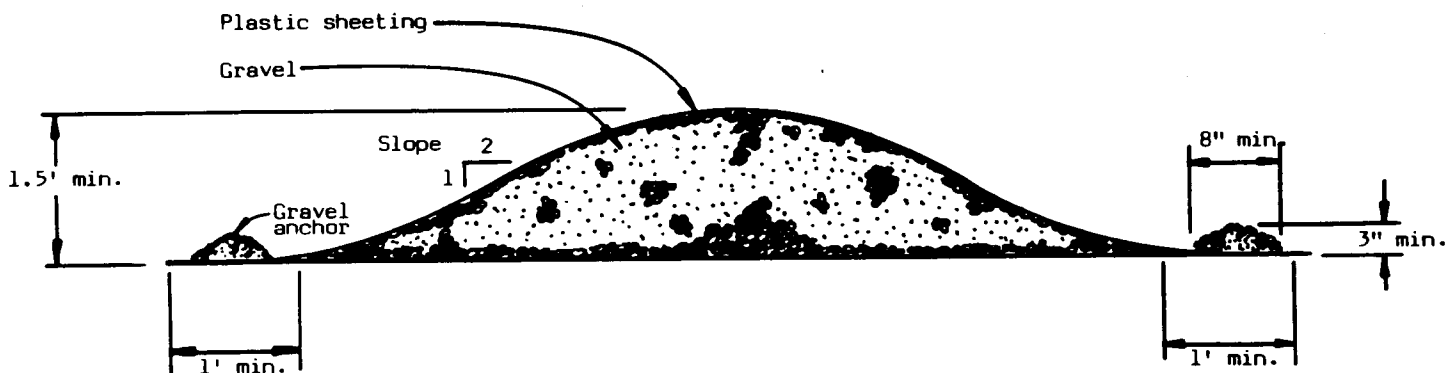

SILTATION BERM

FIGURE III-4

BMP'S FOR RUNOFF COLLECTION

III.5 Waterbars

A waterbar is a berm built at a downslope angle, extending across the length of the roadway.

Purpose: Waterbars reduce erosion by diverting runoff away from the road surface. These erosion control structures can be either permanent or temporary for lightly used unimproved roads.

Specifications: (See Figure III-5)

- 1. Waterbars should extend from the cutbank side of the road across to the fillslope side.**
- 2. Berm height should be twelve (12) to twenty-four (24) inches above the roadbed.**
- 3. Berms should have a downslope angle of between 30% and 40%.**
- 4. Waterbars can be built with a dozer or by hand.**

Maintenance: Properly constructed waterbars should require little or no maintenance. They should be kept open at the discharge end so that water can flow away from the roadway. Silt fence, riprap, or a slash filter windrow may need to be installed below the discharge end of the waterbar to control erosion and trap sediment.

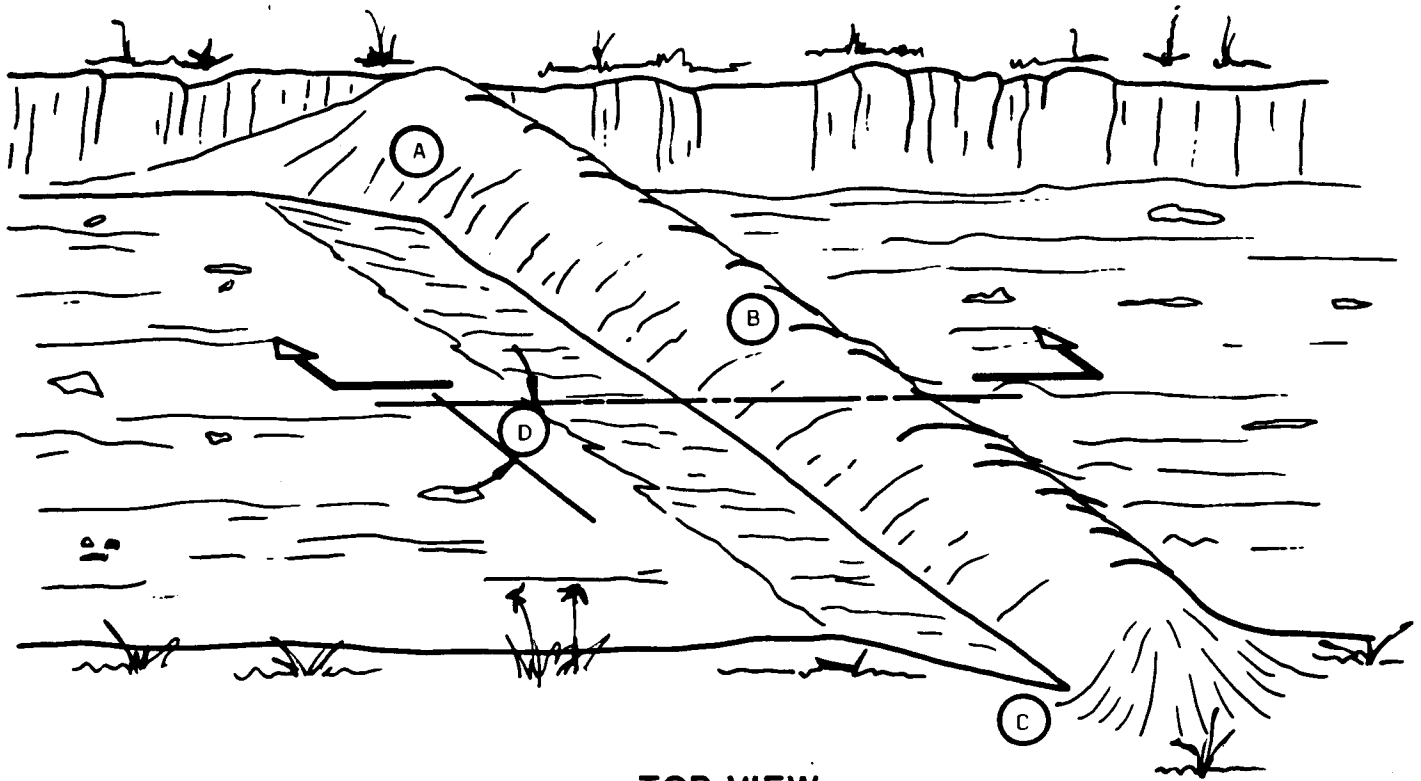

TOP VIEW

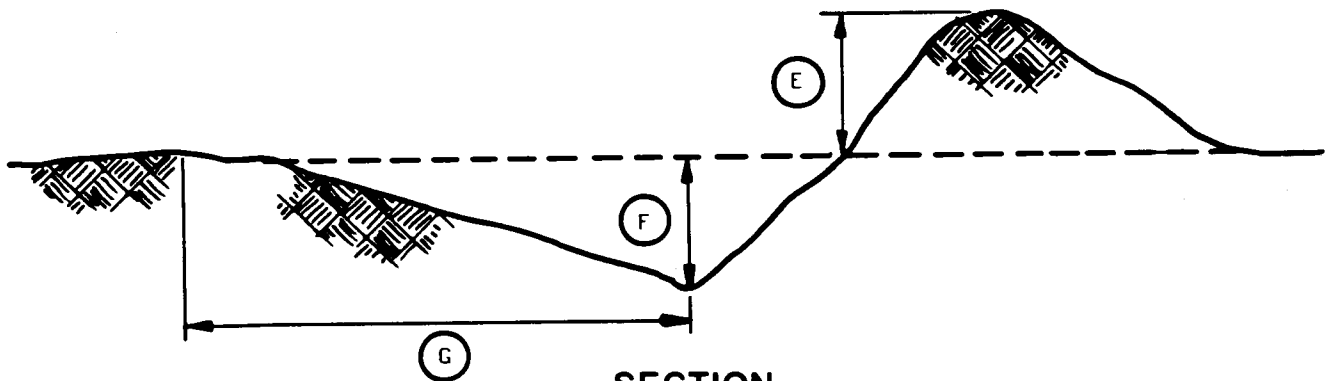

SECTION

WATERBAR (CROSSDITCH). Construction for unpaved forest roads with limited or restricted traffic. Specifications are average and may be adjusted to gradient and other conditions. A, bank tie-in point cut 6 to 12 in. into roadbed; B, cross drain berm height 12 to 24 in. above roadbed; C, drain outlet cut 8 to 16 in. into roadbed; D, angle drain 30 to 40 degrees downward with road centerline; E, height up to 24 in; F, depth to 18 in; G, 36-48 in.

BMP'S FOR RUNOFF COLLECTION

III.6 Corrugated Metal Culverts

Purpose: Corrugated metal culverts are used to remove water from roadways. They can also be used to divert water around areas or structures.

Application: Corrugated metal culverts are permanent water conveyance structures that can be used on all types of roadways.

Specifications: (See Figure III-6)

1. Culverts should be long enough to reach across the roadway and extend beyond the fill slope. In addition, culvert outlets must have erosion control structures installed below them to prevent erosion.
2. When installed to convey a stream under a roadway, they should be large enough to carry the maximum stream volume as well as any additional seasonal runoff. Note: Culvert size should comply with the Idaho Department of Water Resources requirements. (See Appendix A)
3. Install the culvert in firm, compacted soil with a minimum cover of twelve (12) inches of soil.

Maintenance: Culverts need to be inspected on a regular basis. They should be cleaned and/or repaired when necessary.

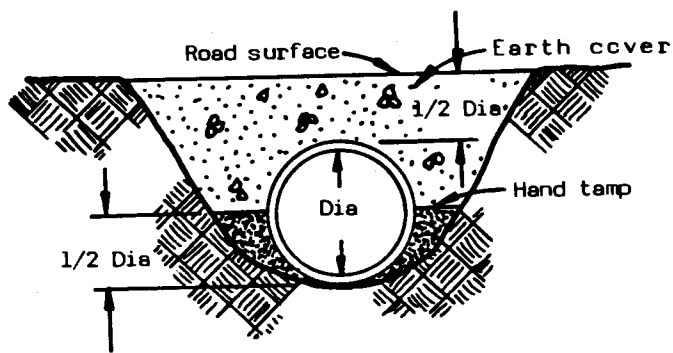
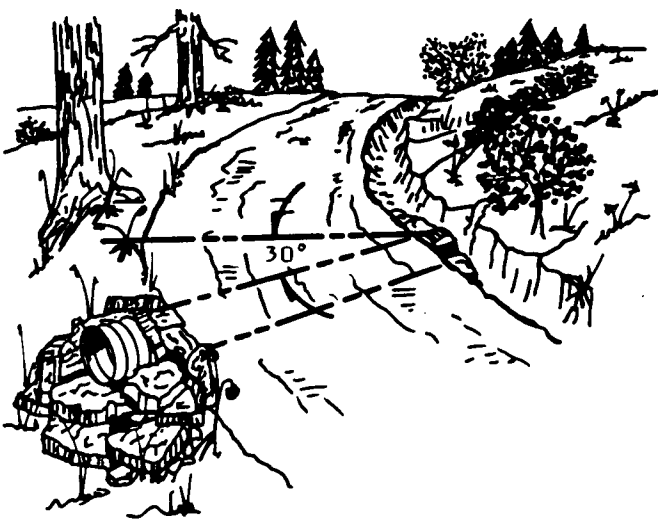

SECTION

CULVERT INSTALLATION

FIGURE III-6

BMP'S FOR RUNOFF COLLECTION

III.7 Drain Fields

A drain field is a drainage system that is designed to discharge infiltrating water and/or ground water away from a site.

Purpose: Drain fields can also be used to intercept and divert seeps. Drain fields must be designed with either a gravity flow outlet or the water must be discharged from the drainage system by pumping.

Application: Drain fields can be used under waste dumps, stockpiles, and tailings impoundments to transport water away from the site. By reducing the water volume and amount of time that it is in contact with potential pollution forming materials, the potential for water quality impacts can be reduced.

Specifications: (See Figure III-7)

1. Drain fields can either be constructed with clean, graded rock (rock of several different sizes), or by using perforated pipe and graded rock. Rocks and piping can also be used in conjunction with geotextile fabric.
2. Drain field constructed of graded rock: Dig a trench. Line it with coarse rock or a geotextile fabric covered with coarse rock. Fill the remainder of the trench with smaller rock free of sand or soil.
3. Drain field constructed of graded rock and perforated pipe: Dig a trench. Line it with coarse rock or a geotextile fabric covered with coarse rock. Put a section of perforated pipe in the trench. (The minimum diameter of the pipe should not be less than 4 inches.) Fill the remainder of the trench with smaller rock free of sand or soil.
4. Do not allow fine soil, silt, or sand to come in contact with the graded rock or graded rock and perforated pipe, as it could clog the drain field and reduce its effectiveness.
5. Drain fields could be a system of interconnected , branched trenches feeding into a central drainage discharge trench.
6. The size of the drain field as well as the depth and width of the trenches is dependant on the volume of water the system must transmit. This is a site specific condition that must be determined by a qualified engineer before the drain field is built.

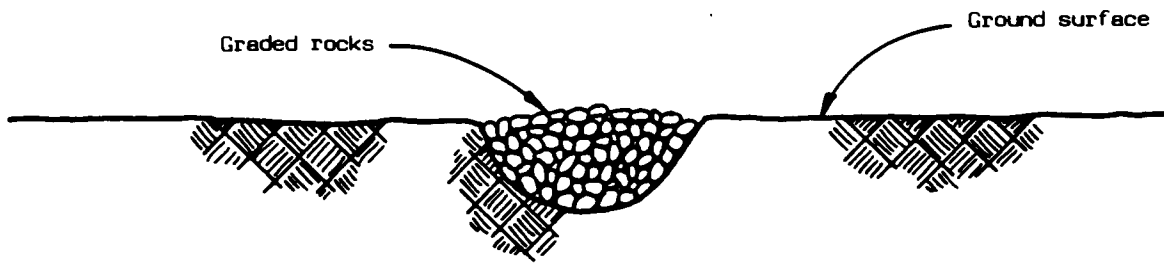

DRAIN FIELD TRENCH LINED WITH GRADED ROCKS

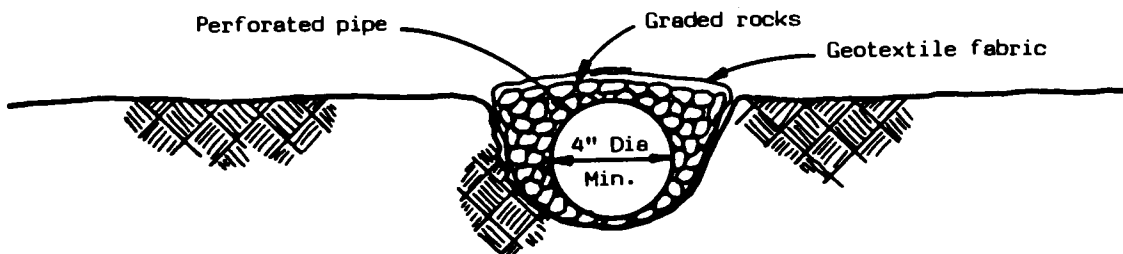

NOTE: Diameter of pipe to be based on the amount of water to be drained.

**TRENCH LINED WITH GEOTEXTILE FABRIC,
GRADED ROCK AND PERFORATED PIPE**

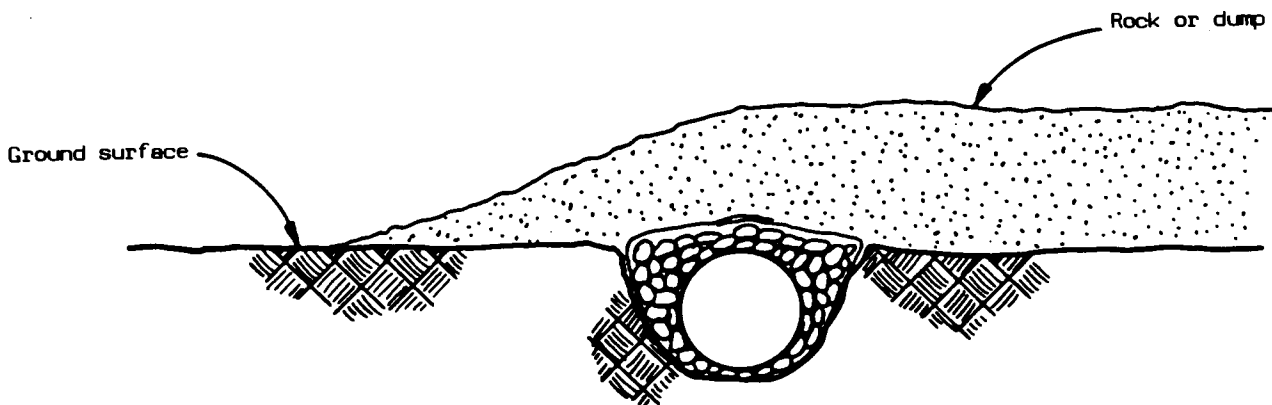

**SURFACE WASTE OR DUMP TO BE PLACED
OVER UNDERDRAIN AFTER CONSTRUCTION**

BMP'S FOR RUNOFF COLLECTION

III.8 Stream Alteration

Stream alteration/diversion should be considered when streams flow through economically minable areas or to divert live water away from a pit, quarry, pond or adjacent impacted area. Stream Alterations can reduce potential water quality impacts caused by mining by routing water away from the area being actively mined. A stream diversion can either be a temporary or permanent measure. Refer to the Idaho Department of Water Resources **Rules and Regulations and Minimum Standards for Stream Channel Alterations.**

Planning:

The following information should be considered and may be required when planning a stream channel diversion:

1. Inventory the following existing stream conditions:
 - a. Develop a Plan view map of the stream or streams to be relocated. Show the present and final location, of the stream, within the valley in relation to access roads, forest roads, land forms at a scale of 1" = 40' with 10' contour intervals. Show location of pools, riffles, transition zones, and natural drop structures in both channels.
 - b. For the stream to be altered, inventory and list the following:

Total pools	Channel length
Total riffles	Valley bottom length
Pool: riffle ratio	Sinuosity
Gradient	
Fish count or available fisheries data	
Cross-section through entire stream length, showing gradient for each reach. Scale 1" = 40'.	
 - c. Develop cross-sections for each stream reach on a scale of 1" = 2', extending at least 10' beyond mean high water mark. If a reach is greater than 200' long, show a cross-section for every 200' length of reach or portion thereof.

For each stream reach, inventory and list the following:

Type of reach	Gradient
Average depth	Area of reach
Average width	Average size of bed material
Width/depth ratio	
Cobble embeddedness	
Volume of large organic debris	
Bank stability and form description	

BMP'S FOR RUNOFF COLLECTION

- d. Obtain or calculate flow data for the following storm events:

2 year - 24 hour (Bankfull discharge)
10 year - 24 hour
25 year - 24 hour
50 year - 24 hour

Show a representative riffle cross-section overlaid with flood water elevations for the specific storm events.

2. Develop a reclamation plan, based on the stream channel inventory, that will provide comparable or improved stream channel characteristics, based on stream stability and fisheries habitat.

Construction Specifications:

1. Plan to relocate the stream where no mining will occur.
2. Excavate the new stream channel to specifications outlined in the stream reclamation plan and stream channel alteration permit.
3. Install erosion control, channel stabilization structures, and fisheries improvements. These items will be outlined in the stream reclamation plan and/or stream channel alteration permit.
4. Downstream control structures should be installed to help break the stream's velocity. This will enhance fish habitat, providing there are fish in the stream. (Refer to BMP III.9 Drop Structures)
5. Establish vegetative cover such as grass and willows on the banks above the water line.
6. There should be no stream diversion until a new channel has been constructed to standards specified in the stream reclamation plan.

Maintenance:

1. Monitor conditions at the altered stream and complete repair work on the channel as needed.
2. The reconstructed channel should be allowed to function for at least one year before mining is conducted in the original channel location. If serious stability problems develop in the new stream channel, flows can be returned to the original stream channel.

BMP'S FOR RUNOFF COLLECTION

III.9 Drop Structures

Specifications: (See Figure III-9)

Place large, hard, angular rocks in an V shaped pattern across the width of the stream. Note: Rocks must be large enough that the water velocity does not dislodge them and carry them downstream.

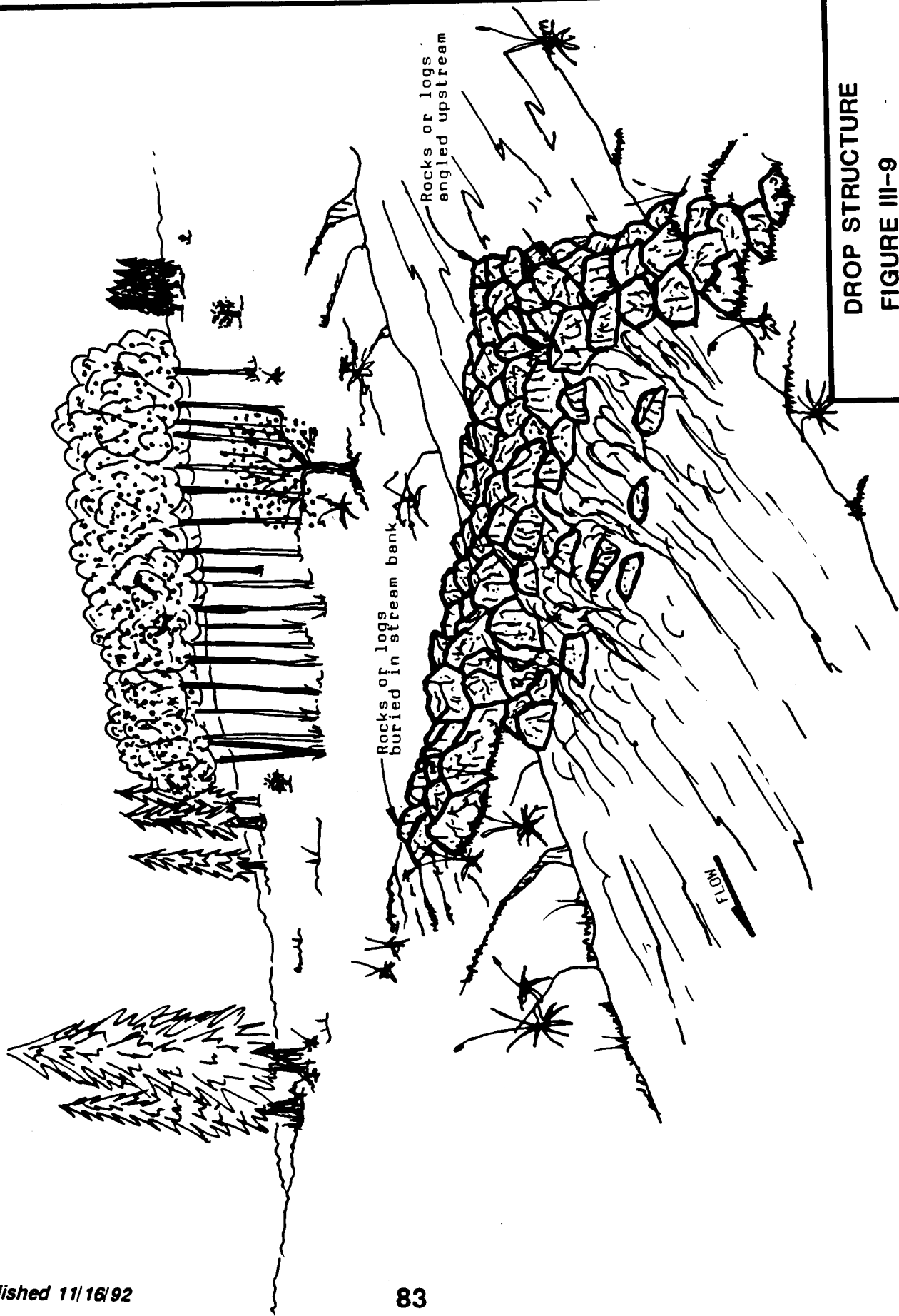

DROP STRUCTURE
FIGURE III-9

BMP'S FOR RUNOFF COLLECTION

III.10 Rolling Dips

Rolling dips are built into the road, during construction, using the natural contours of the land.

Purpose: Rolling Dips are designed to divert surface runoff off road surfaces.

Specifications: (See Figure III-10)

1. The dip should be approximately one (1) foot in depth from the surface plane of the road. The upgrade approach to the bottom of the dip should be approximately sixty (60) feet. The downgrade approach to the bottom of the dip should be approximately twenty (20) feet in length.
2. The dip should cross the road at nearly a 90 degree angle and should be outsloped approximately five percent.

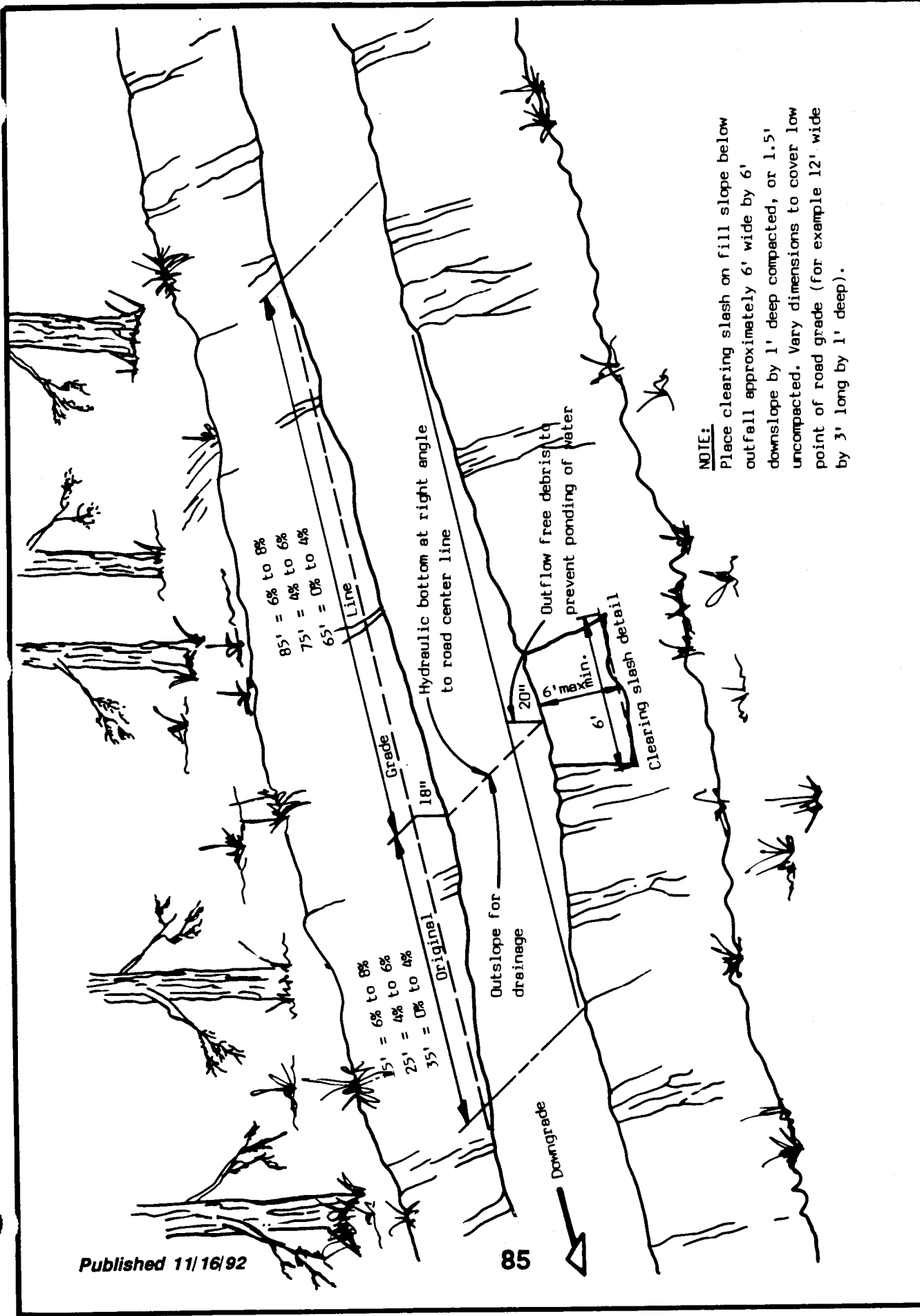

NOTE:
 Place clearing slash on fill slope below outfall approximately 6' wide by 6' downslope by 1' deep compacted, or 1.5' uncompacted. Vary dimensions to cover low point of road grade (for example 12' wide by 3' long by 1' deep).

ROLLING DIP DETAIL
FIGURE III-10

BMP'S FOR RUNOFF COLLECTION

BMP'S FOR RUNOFF COLLECTION

III.11 ROAD SLOPING

Road sloping is built into the road during construction.

Purpose: Sloped roads are designed to divert surface water off the entire road surface so that water does not concentrate in any specific location.

Specifications: (See Figure III-11)

1. The slope should be approximately 1-2% from the cut slope to the fill slope.
2. Berms on the outside of the road should be limited or removed to allow water to flow off the road surface.
3. A slash filter windrow should be used at the toe of the fill slope to prevent excessive erosion and sediment transport. (See BMP V.7)

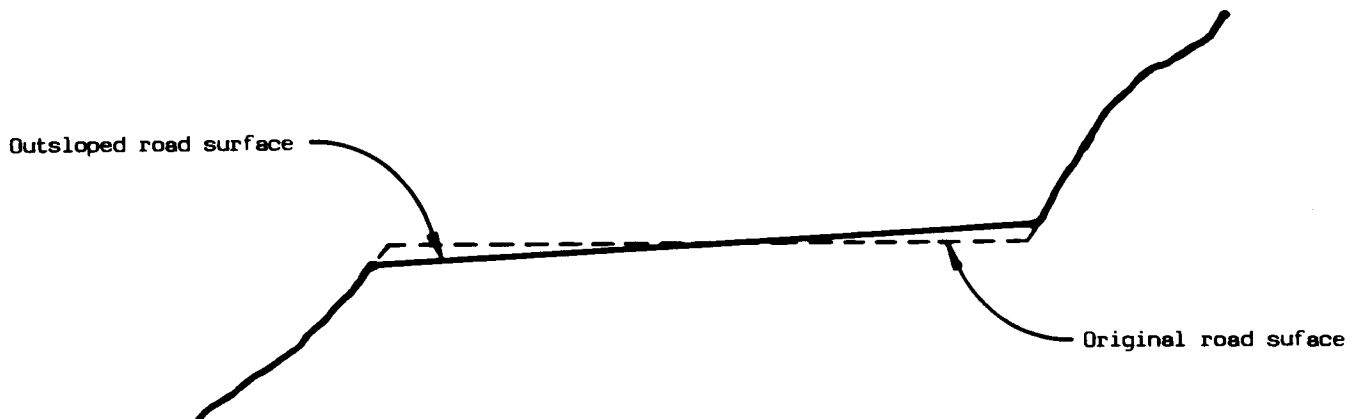

ROAD SLOPING

FIGURE III-11

BMP'S FOR RUNOFF COLLECTION

III.12 Roadway Surface Water Deflectors

A roadway surface water deflector is a runoff interceptor built of treated wood and a conveyor belt. The deflector is installed across the roadbed to convey surface water off the roadbed.

Purpose: To deflect surface water off roadways to reduce erosion. The deflector can be installed on lightly used, unpaved roads with steep grades (greater than six percent).

Specifications: (See Figure III.12)

1. Obtain a section of two-ply rubber conveyor belt 12 inches (wide) x 20 feet (long) x 1/4 inch, more or less, 1/16 inch (thick) and (2) 2 inch x 6 inch x 20 feet pieces of treated lumber.
2. "Sandwich" the conveyor belt between the two pieces of treated lumber so one edge of the conveyor belt is flush with the bottom of the treated lumber. Nail the treated lumber together with 20 d galvanized nails. The conveyor belt should extend 6 inches, more or less, above the top of the nailed together treated lumber.
3. Excavate cut in roadway at a 30° angle to the road surface.
4. Install deflector so that the treated lumber is 3 inches - 4 inches below the surface of the road (this will allow 2½ inches - 3½ inches of the conveyor belt to project above the road surface). Burying the lumber as specified will help prevent damaging it when the road is graded.

Maintenance: These water deflectors should be inspected on a regular basis and should be repaired or replaced as needed.

ROADWAY SURFACE-WATER DEFLECTOR SPECIFICATIONS

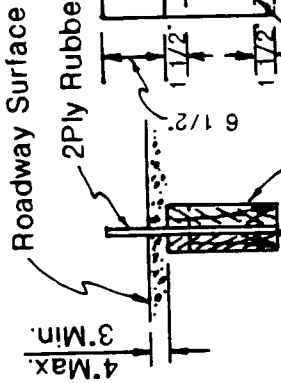
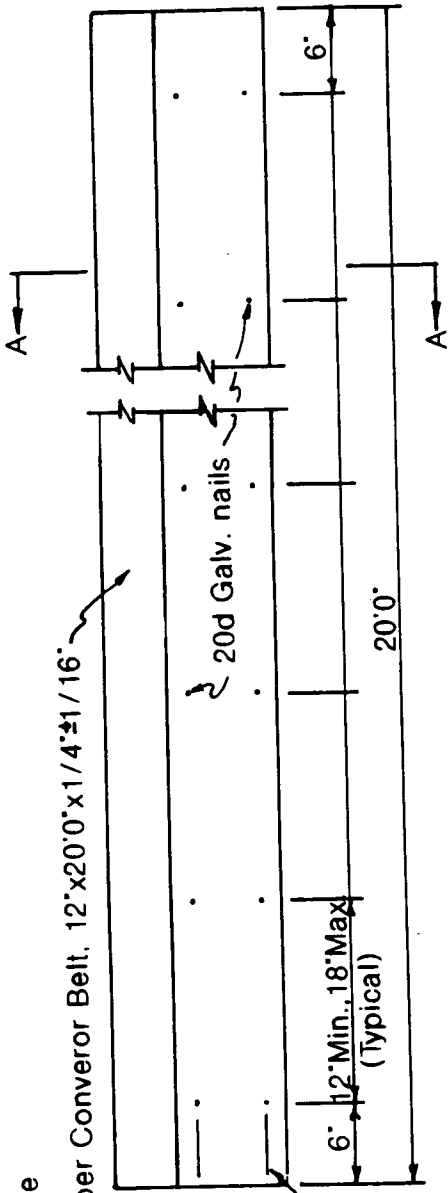

2"x6"x20'0" Treated Timber
(May be one or two pieces,
each side, stagger joints 4'0"
min.)

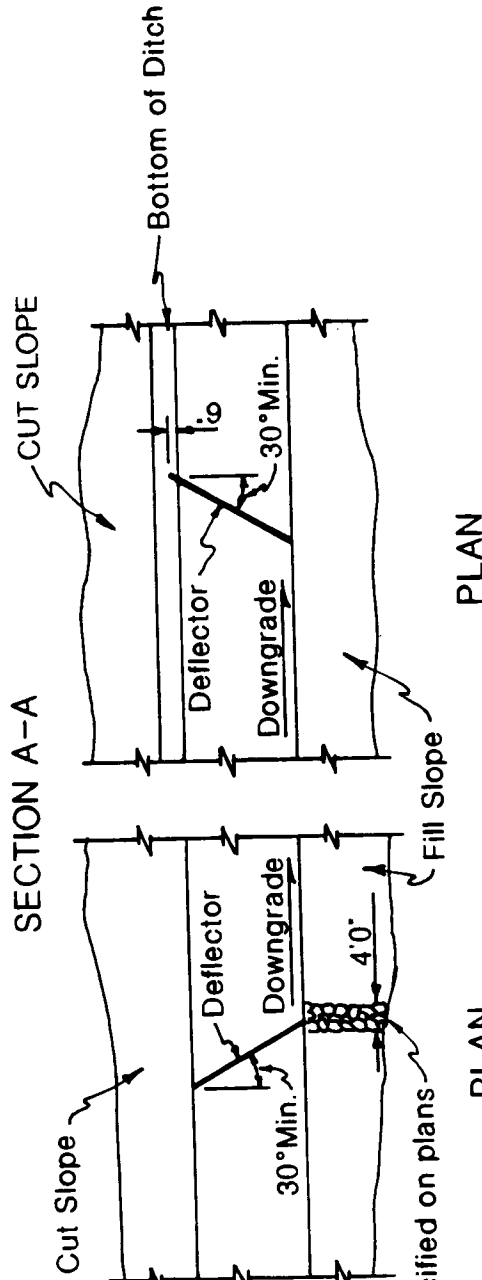

SECTION A-A

Cut Slope

CUT SLOPE

Deflector

Downgrade

Deflector

Downgrade

Riprap when specified on plans

Fill Slope

PLAN

PLAN

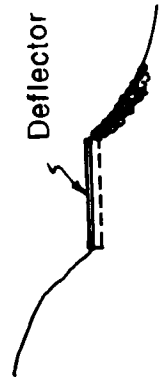

ELEVATION

ROAD WITHOUT DITCH

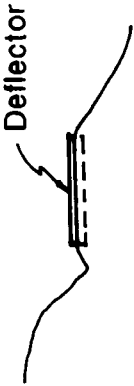

ELEVATION

ROAD WITH DITCH

SURFACE WATER DEFLECTOR
FIGURE III-12

Section IV: BMP'S FOR RUNOFF DISPERSION

Contents and Applicability

Best Management Practices (BMP's):

- IV.1 Serrated Slopes.** Small steps on a slope face which are useful for providing favorable sites for establishment of vegetation and controlling runoff. This method is limited to soils that have medium to high cohesion properties.
- IV.2 Benched Slopes.** Large steps in a slope face useful for providing favorable sites for establishment of vegetation and controlling runoff. Benches can help stabilize large excessively steep slopes in highly cohesive material. This method is most applicable in newly constructed areas.
- IV.3 Level Spreader.** An outlet constructed, at zero grade, across a slope to help disperse concentrated runoff, allow for water infiltration, and allow sediment to settle out of the water.

BMP'S FOR RUNOFF DISPERSION

IV.1 Serrated Slopes

Serrating slopes involves cutting small (1-2 ft) horizontal steps in a hillside.

Purpose: Serration reduces slope lengths, breaks up and loosens soils so that seeds can take hold, and establishes favorable sites for revegetation and water infiltration.

Specifications:

Serration (Scarifying): These techniques work best on cohesive soils or soft rocks that can be excavated without ripping. Slopes must be gentle, preferably 2:1 or flatter.

1. Serrated slopes can be built with a dozer.
2. Serrations should be horizontal and should follow the contour of the slope.
3. Excavation of a series of serrated benches should be in opposite directions, from the top of the slope to the bottom, so that the build up of loose material at the end of the bench can be minimized.
4. Serrated/scarified ground should be seeded as soon as possible after the excavation work has been completed.

BMP'S FOR RUNOFF DISPERSION

IV.2 Benched Slopes

Benching slopes involves constructing continuous horizontal benches on a slope to reduce slope lengths, enhance stability, and revegetative efforts.

Application: Slope benching is applicable in new construction on cut slopes in soft rock that can be excavated by ripping. This method does not work well on cut slopes excavated in soft rock where the bedding lies perpendicular to the cut slope.

Specifications: (See Figure IV-2)

- 1. The vertical cut of the bench should be between two (2) feet and four (4) feet high.**
- 2. The vertical cut of the upper bench or terrace should begin immediately above the horizontal cut of the lower terrace.**
- 3. Benches should be horizontal. They should parallel the roadway or cut slope.**
- 4. Excavation of each bench should be in an opposite direction from the preceding one, from the top of the slope to the bottom, to reduce the build up of unconsolidated material at the end of the bench.**

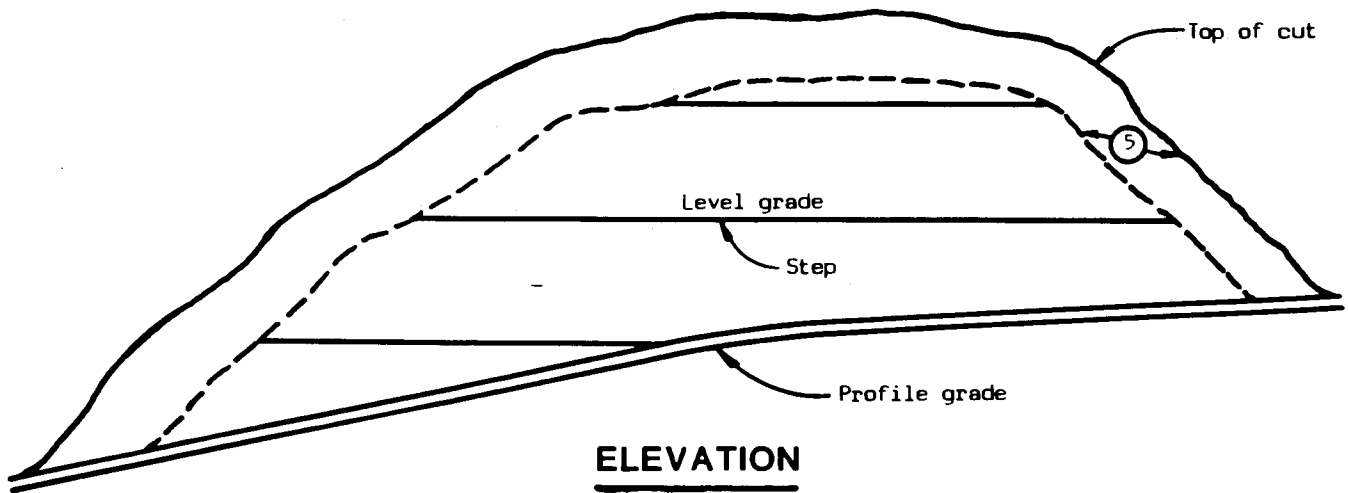

ELEVATION

- ① Staked slope line
- ② Step rise height 2 - 20 feet; in soil 2 - 4 feet, in rock 2 - 20 feet
- ③ Step tread width = Slope ratio X step rise
- ④ Step termini width = 1/2 step tread
- ⑤ Overburden
- ⑥ Slope rounding
- ⑦ Original grade line

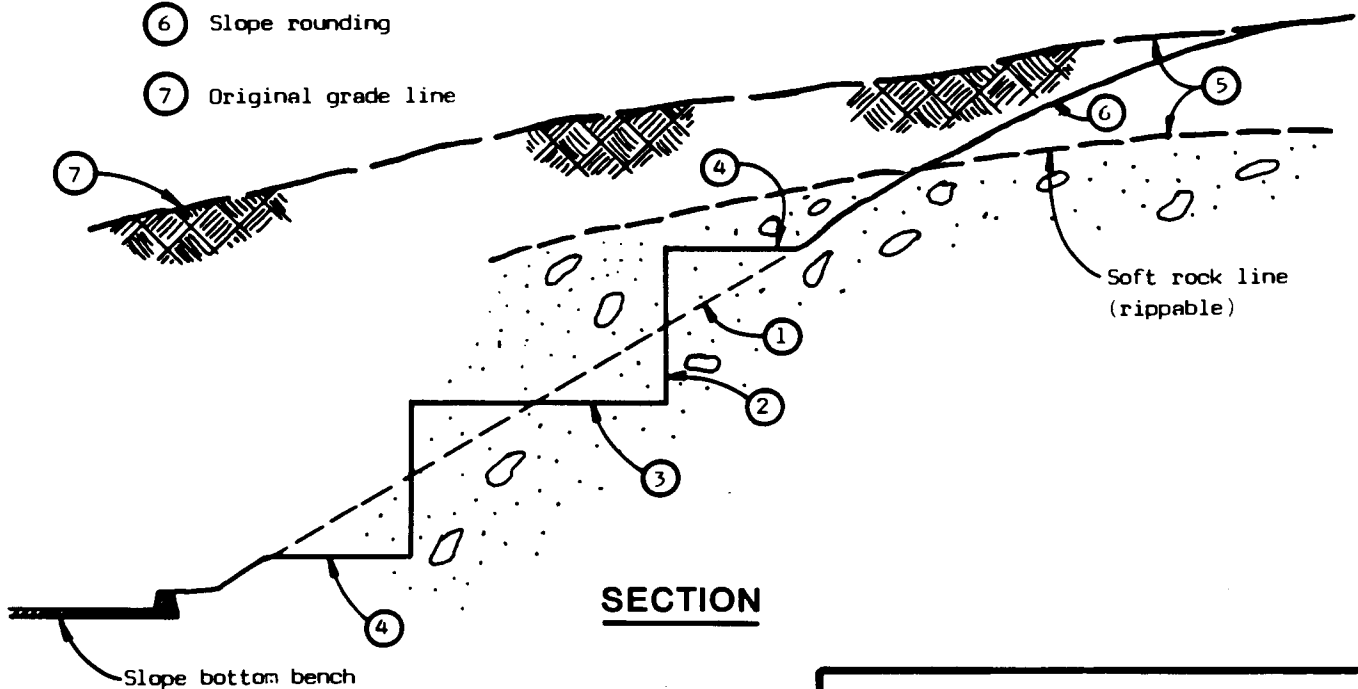

SECTION

BMP'S FOR RUNOFF DISPERSION

IV.3 Level Spreaders

Level spreaders are designed to disperse surface runoff over a wide, relatively flat area.

Purpose: Runoff velocities can be reduced by using level spreaders. Reduced velocities lessen erosion, allow sediment to settle out of runoff water and enhance infiltration.

Application: Level spreaders can be used in locations where concentrated runoff from unvegetated ground needs to be controlled, the water velocities dissipated, and the water dispersed over a broad surface area.

Specifications: (See Figure IV-3)

1. Level spreaders should be constructed in undisturbed soil.
2. Length - The level spreader should be at least fifteen (15) feet long for every .10 cfs (cubic foot per second) discharge of water.
3. Width - A minimum of six (6) feet from the centerline to the outside edge of the level spreader.
4. Level spreaders should not be built on slopes steeper than 3:1 (approximately 33%).

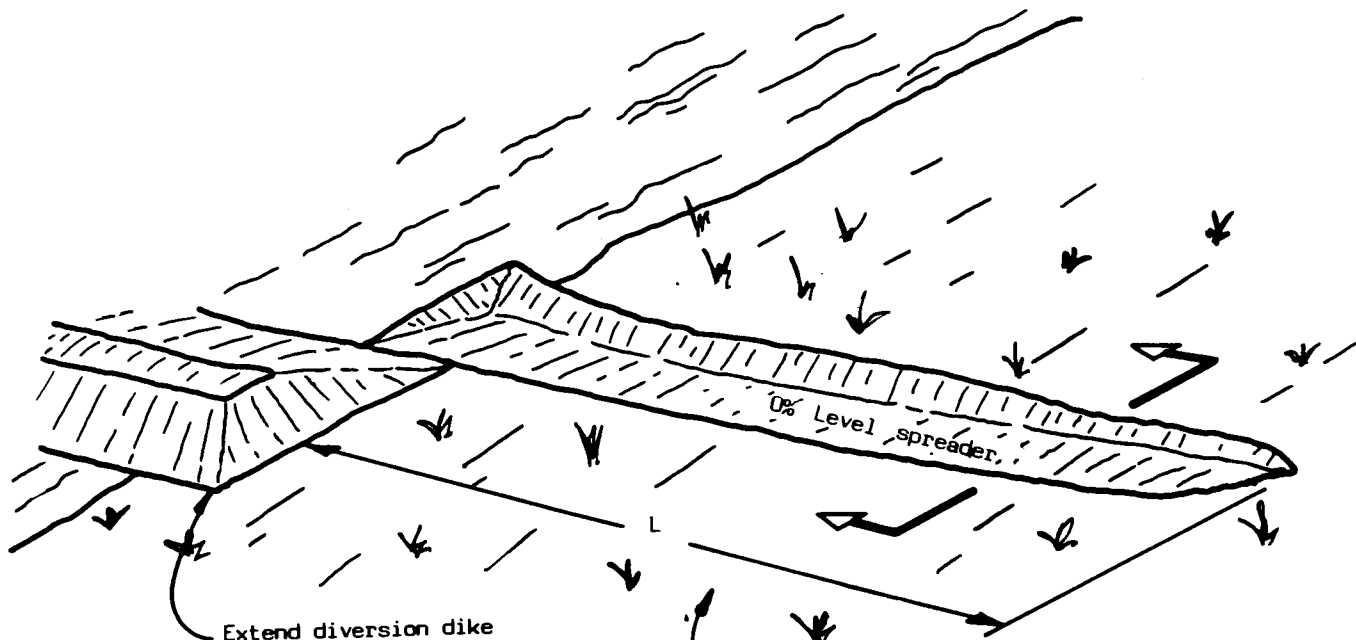

Extend diversion dike at least 2' beyond disturbed area into stabilized area.

Undisturbed soil stabilized with vegetation. Repair areas damaged during construction.

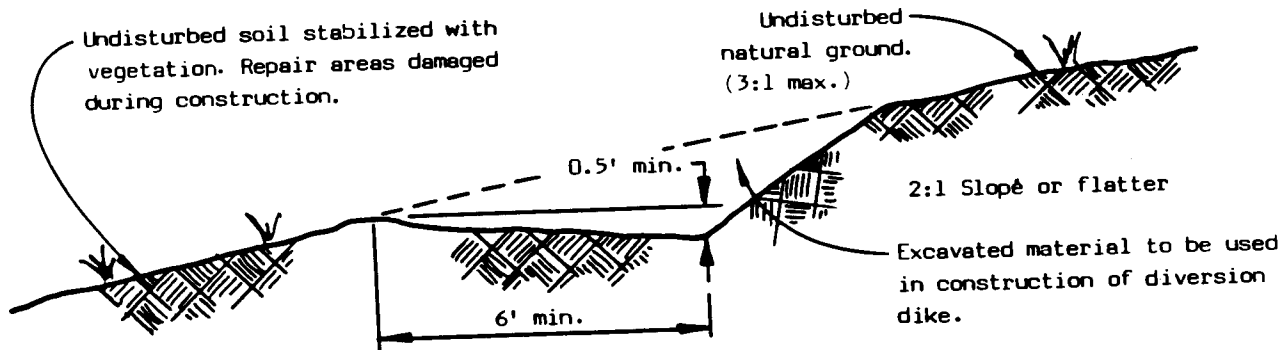

SECTION

Section V:

BMP'S FOR SEDIMENT COLLECTION

Contents and Applicability

Best Management Practices (BMP's):

- V.1 Straw Bale Barrier.** Straw bales can be used where temporary diversions or berms are required. The straw allows water to filter through and retains the sediment. Frequent inspection is necessary.
- V.2 Sediment Traps or Catch Basins.** A basin for capturing sediment from runoff water.
- V.3 Vegetated Buffer Strip.** An undisturbed area containing native vegetation over which runoff water flows before entering streams or lakes.
- V.4 Silt Fence/Filter Fence.** A barrier constructed of filter cloth which is designed to trap sediments while allowing runoff water to flow through the barrier.
- V.5 Brush Sediment Barriers.** A sediment barrier constructed of brush or brush and filter fabric.
- V.6 Sediment/Settling Ponds.** A pond constructed, in a drainage or draw, which catches and holds sediment laden water.
- V.7 Slash Filter Windrows.** A sediment trap built of windrowed slash.
- V.8 Log and brush check dams.** A sediment trap built of logs and brush.

BMP'S FOR SEDIMENT COLLECTION

V.1 Straw Bale Barriers

Purpose: Straw bales can be used as a temporary berm, diversion, or barrier to help contain sediment on site by catching and filtering spring runoff.

Application: The barriers may be used across small swales, in ditches, and at the toe of bare slopes where there is a temporary, large volume of sediment laden runoff.

Specifications: (See Figure V-1A and V-1B)

1. Bales should be laid on their side and staked in place with either wooden or metal stakes. The stakes should be driven through the bale and at least one (1) foot into the ground.
2. Piping (flow of water underneath the bales) can be reduced by placing the bales in a small (six inches deep) trench.
3. Wire or nylon tied bales last longer than bales tied with twine.

Maintenance: Straw bale sediment barriers should be inspected on a regular basis and immediately repaired or replaced when damaged.

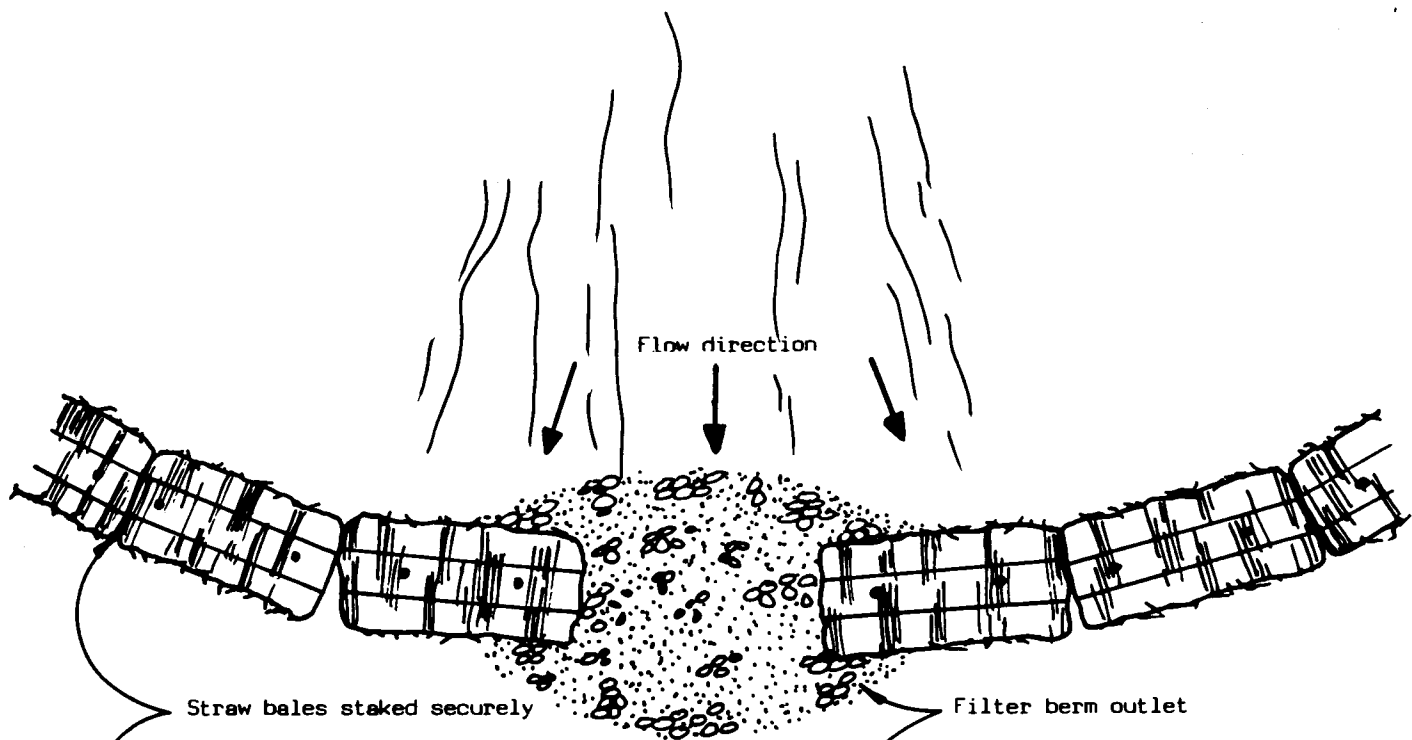

PLAN VIEW

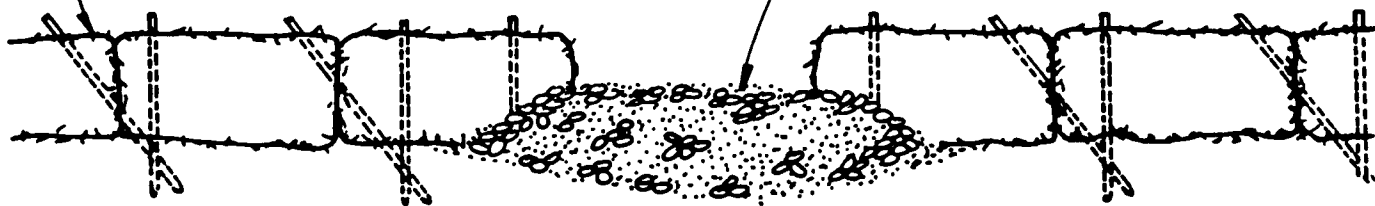

ELEVATION

Semi-pervious barrier of straw bales with more pervious embankment of sand and gravel for spillway.

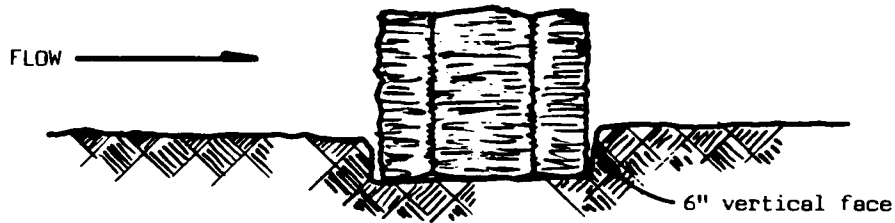

EMBEDDING DETAIL

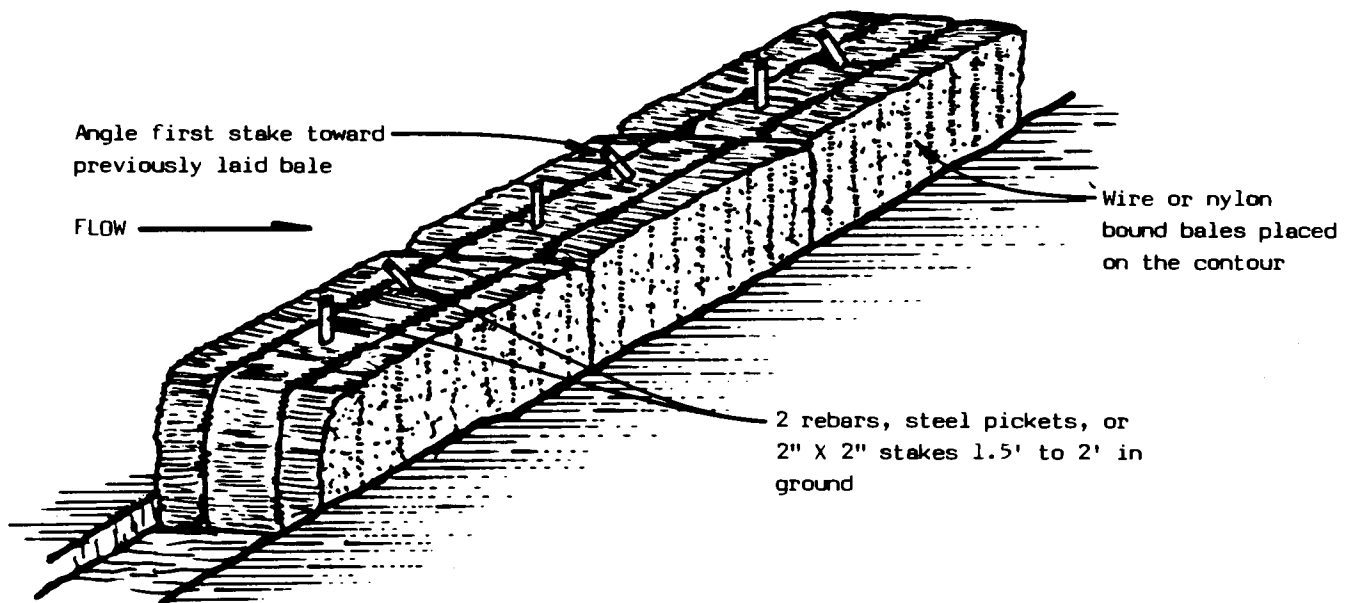

ANCHORING DETAIL

BMP'S FOR SEDIMENT COLLECTION

V.2 Sediment Traps or Catch Basins

A sediment trap or catch basin is a temporary or permanent structure used to catch and store sediment laden surface runoff.

Purpose: Small temporary structures should be used to catch runoff containing sediment from temporary roads and construction sites. Larger permanent basins should be constructed to catch periodic sediment laden runoff from permanent erosion control structures, i.e. culverts, water bars, etc.

Specifications: (See Figure V-2)

1. The basin should be large enough to retain sediment from major seasonal storm events. It will need to be cleaned periodically during periods of high runoff and each fall.
2. The slopes of the catch basin should be seeded, if possible. This will increase their stability and help decrease additional erosion.
3. Large, permanent structures may require spillways so water can be decanted. Either a pipe spillway, which discharges to vegetated ground, or a natural outflow covered with geotextile fabric is acceptable.

Maintenance: Catch basins should be inspected on a regular basis and should be cleaned out and/or repaired as needed.

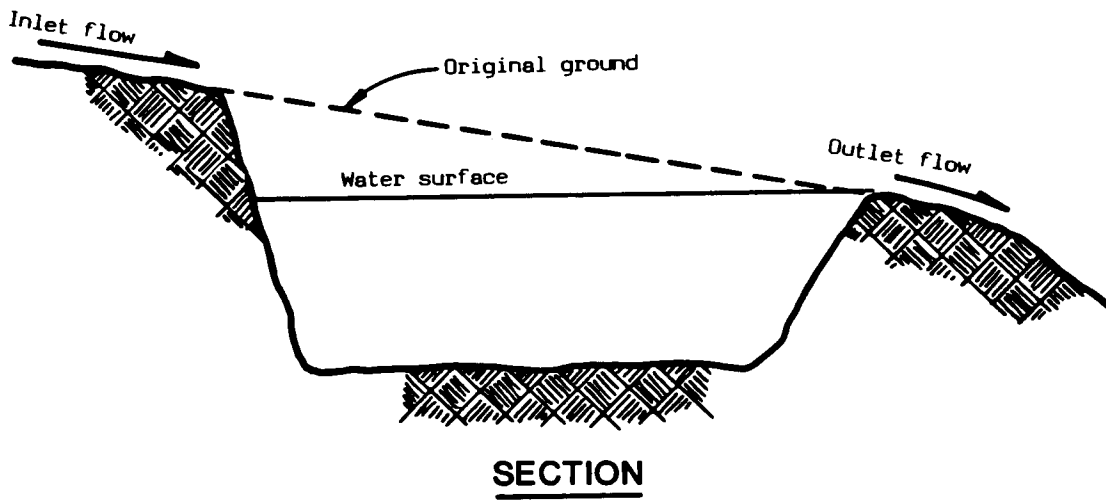
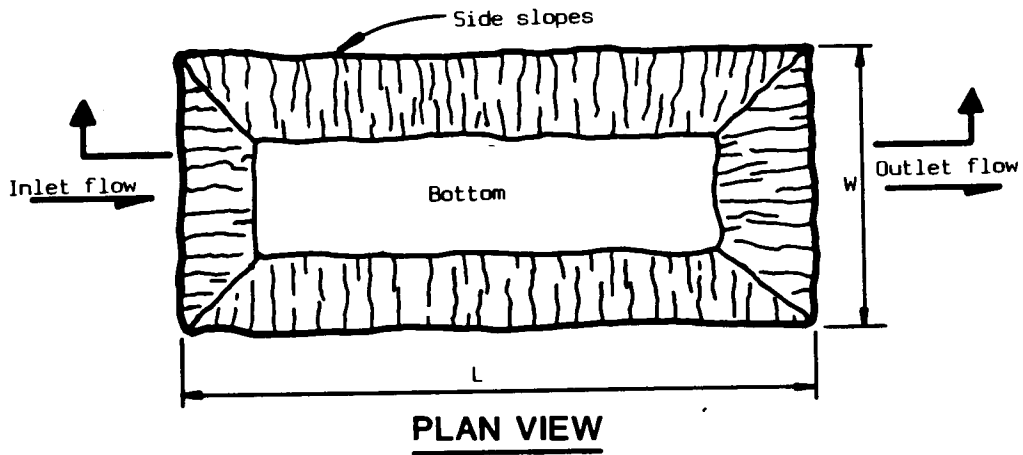

BMP'S FOR SEDIMENT COLLECTION

V.3 Vegetated Buffer Strip

Purpose: Vegetated ground can serve as a permanent or temporary trap to catch and hold sediment from runoff water flowing across it.

Application: A strip of vegetated ground could be established at many locations between the source of sediment and live water sources. The vegetative cover could be either native or planted.

Specifications:

1. Try to direct sediment laden water onto naturally vegetated or planted ground.
2. Tall, dense stands of grass form good sediment traps, as do willows and alder. The willows and alder can either be native or planted. A combination of grasses and willows or alder is also effective.
3. Fertilizing seeded or planted ground will enhance growth.
4. Sediment laden water should not be directed onto vegetated buffer strips within 25 feet of a Class II stream or within 75 feet of a Class I stream.

Maintenance: Native vegetated ground should not need maintenance. Planted ground should not be used as a sediment trap until vegetation is well established. The area should be inspected periodically to ensure that water running across the vegetated ground is not causing additional erosion.

BMP'S FOR SEDIMENT COLLECTION

V.4 Silt Fence/Filter Fence

A silt fence/filter fence is a low fence made of filter fabric, wire, and steel posts used to filter sediment out of runoff water before it is discharged.

Purpose: Silt fences should be used on sites where there is a potential for sediment laden runoff caused by man made surface disturbance to be discharged.

Application: Silt fences should be used on small ephemeral drainages where surface water collects or leaves a mine site. Silt fences are easier to maintain and remove without creating lasting impacts to the environment. They must be cleaned periodically to maintain their effectiveness.

Specifications: (See Figure V-4)

1. Construction material: filter fabric, steel fence posts, wire.
2. Excavate a trench at the uphill side of the planned fence location to a depth of at least six (6) inches.
3. Drive steel fence posts into the ground, to a depth adequate to make the fence stable, on the downhill side of the trench.
4. Stretch the filter fabric between the posts and wire it in place.
5. Lower the fabric into the trench and cover with rocks and compacted soil so water can not wash out under the fabric.

Maintenance: Silt fences should be inspected periodically, especially during periods of high runoff. They should also be cleaned and repaired on a regular basis and every fall.

Silt fencing may not be as effective as straw bales in areas with a high clay content as the clay tends to clog the filter fabric and impede the flow of water.

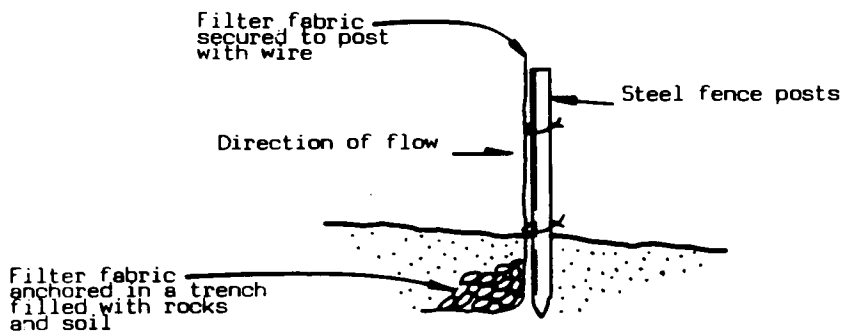
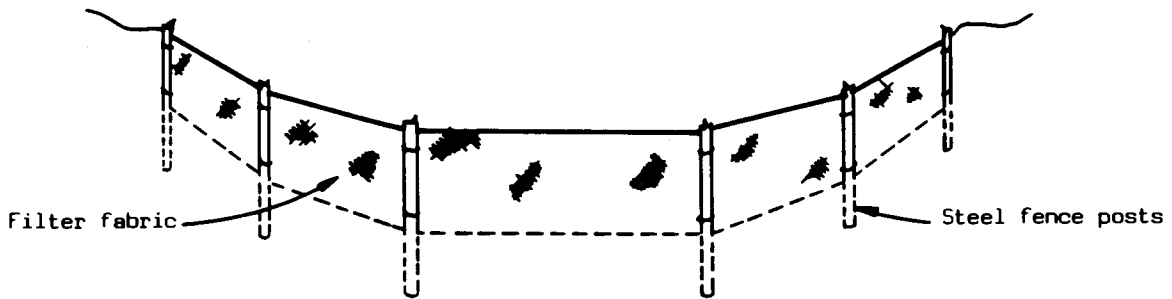

SECTION

BMP'S FOR SEDIMENT COLLECTION

V.5 Brush Sediment Barrier

Purpose: Barriers constructed of brush or brush and filter fabric can serve as an effective sediment trap if runoff water is diverted through them.

Application: Brush sediment traps can be an effective permanent or temporary erosion control structure and are used below any surface disturbance. Brush sediment barriers can also enhance reclamation efforts by providing a source of slash to regrade over the mine site, before seeding.

Specifications: (See Figure V-5)

1. Pile brush in a semi-circle on the ground.
2. Dig a four-inch by four-inch trench on the uphill side of the brush pile adjacent to the pile.
3. Place filter fabric in the trench. Cover and compact with soil and rocks so water will not run under the fabric.
4. Place the filter fabric over the brush pile. Anchor in place as shown in Figure V-5.

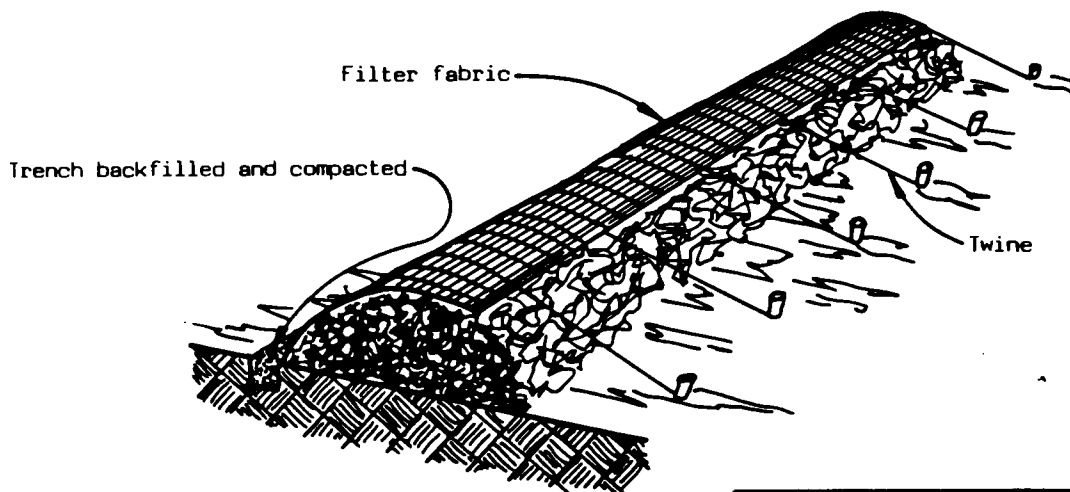
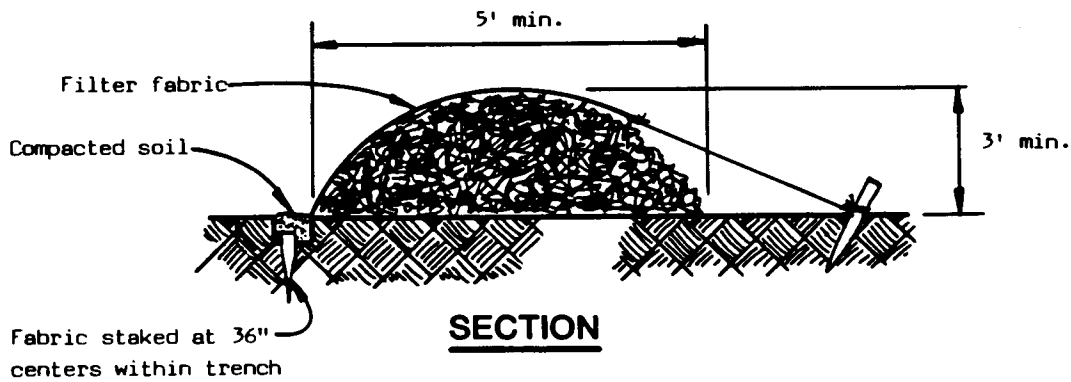
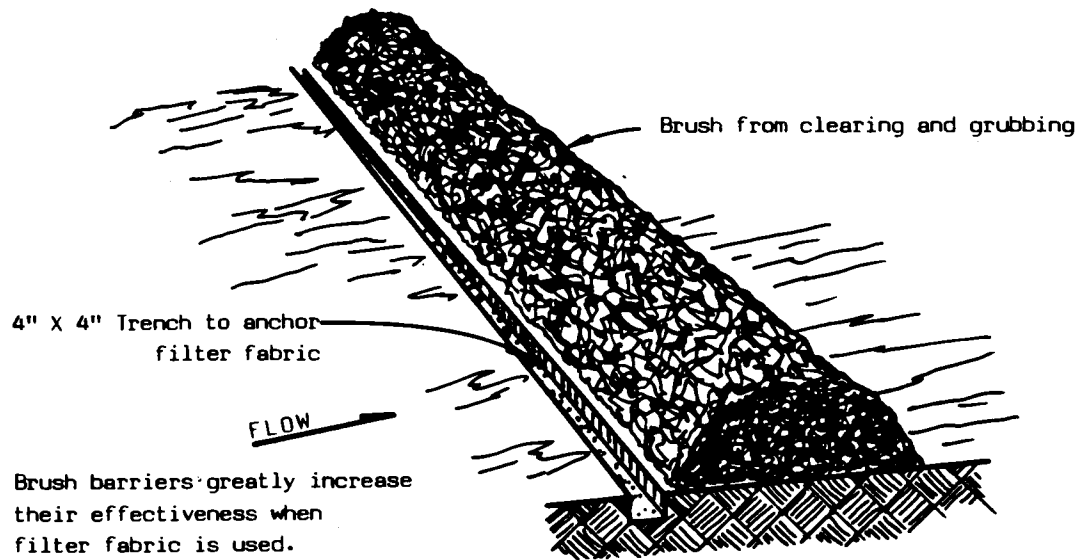

BMP'S FOR SEDIMENT COLLECTION

V.6 Sediment/Settling Pond

Purpose: Sediment ponds can serve as effective sediment traps, holding and storing sediment laden water for long periods of time. They can be designed with a spillway so that sediment free water can be allowed to decant off during periods of peak flow. Excess sediment free water could also be removed from the settling pond by land application, which entails dispersing it onto vegetated ground through pipes and a sprinkler system.

Application: Sediment/settling ponds are effective permanent holding facilities for sediment laden water that runs off a mine site. They can also be used to catch and retain water discharging from diversion dikes and drain fields, and they can be built below tailings dams to catch and hold seepage that might contain toxic substances.

Specifications: (See Figure V-6)

1. Construct a well compacted semi-circle shaped berm at the lowest collection point on a bare slope.
2. Make the base of the berm wider than the top. This will increase its strength.
3. Build the berm high enough so that the pond can retain all runoff water and any excess from a major storm event.
4. Design a spillway into the berm so that sediment free water can be decanted off if necessary. The berm could be a sloped ramp, covered with jute matting, or a wooden, rock riprapped or concrete spillway.

Maintenance: Sediment ponds should be inspected on a regular basis, especially after peak runoff periods. Repairs should be made when needed.

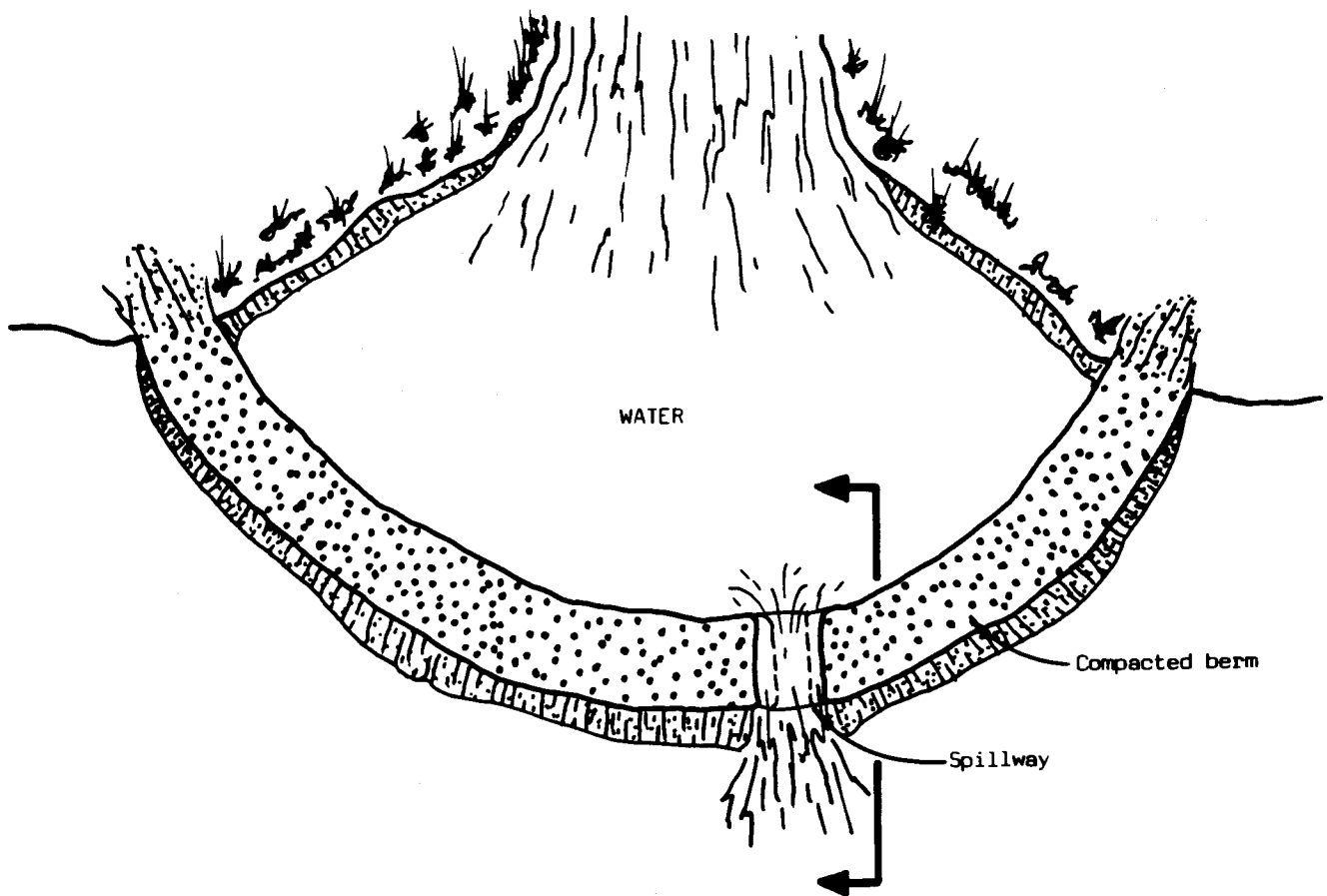

PLAN VIEW

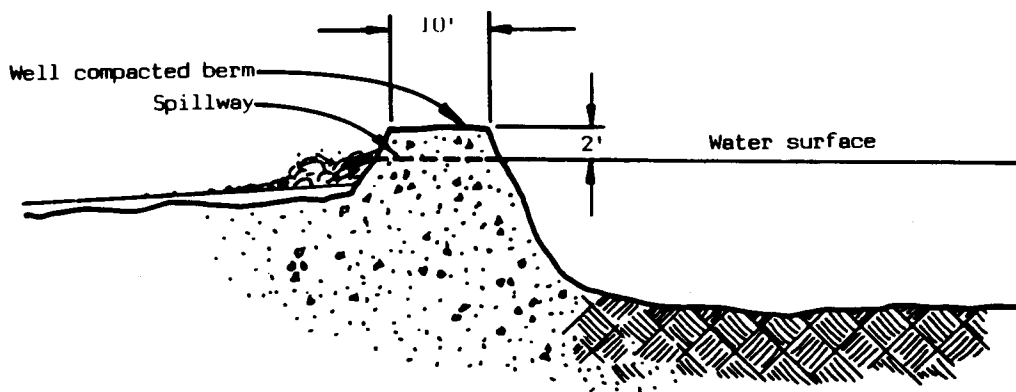

CROSS SECTION

BMP'S FOR SEDIMENT COLLECTION

V.7 Slash Filter Windrow

A slash filter windrow is a sediment barrier comprised of "windrowed" slash.

Purpose: Designed to catch and trap sediment coming off un-vegetated ground.

Application: Slash filter windrows are used to catch and retain sediment along road fill slopes at the toe of waste dumps, or adjacent to bare ground in steep terrain.

Specifications: (See Figure V-7)

1. When clearing an area of trees, stockpile the slash at designated sites so that it will be readily available for windrow construction.
2. Construct the windrow by removing a cull log of at least eighteen (18) inch diameter from the stockpile. Place it in a position at the toe of the fill or waste dump. The long dimension of the log should be parallel to the fill. Anchor the log in place against stumps, rocks, or other trees.
3. Stockpile slash on the fill slope, above the cut log. Compact the slash by tamping it in place with the bucket of the construction equipment you are using. Slash needs to be tamped in place so material will not flow under or through it.

Effectiveness: Slash filter windrows constructed below logging roads have proven to be from 75 to 85% effective in catching and retaining sediment.

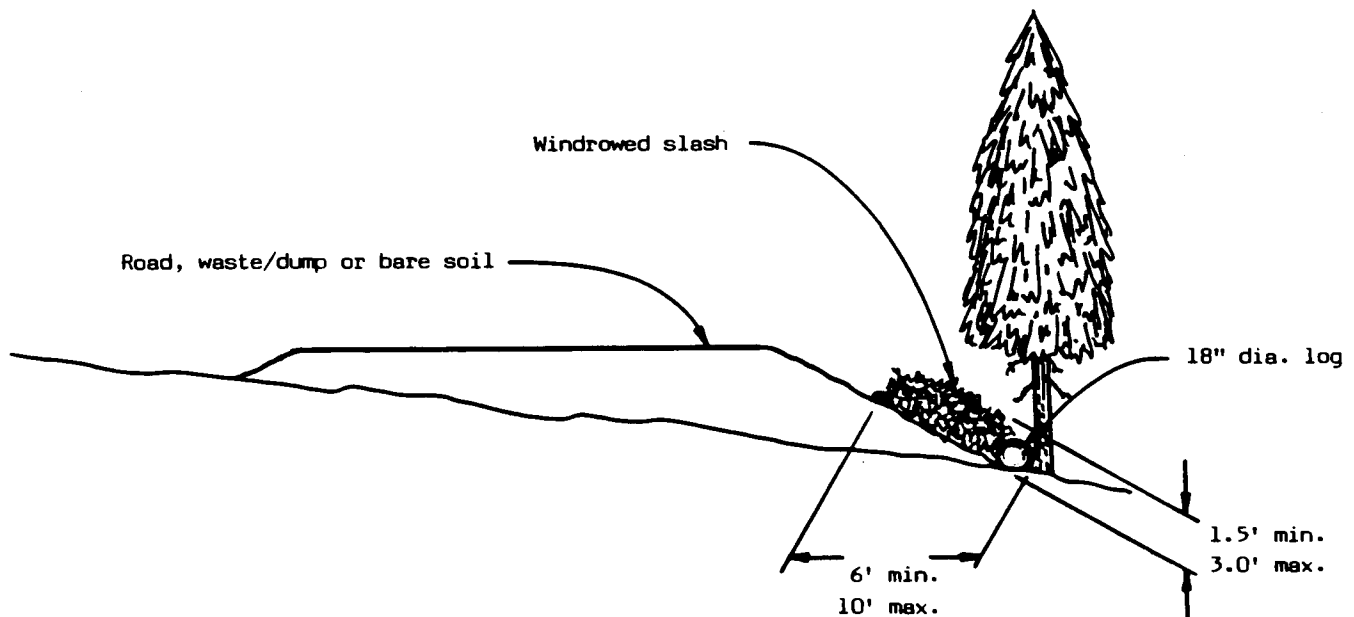

SLASH FILTER WINDROW

FIGURE V-7

V.8 Log and Brush Check Dams

Purpose: Log check dams can be used to prevent or reduce erosion of banks and bottoms of channels, streams, and drainage-ways by reducing gradients and flow velocities.

Application: Log check dams can be installed in streams, channels, drainage-ways and ditches. Note: check dams can also be made using rocks, or wire fencing (see Figure V-8B or V-8C).

Specifications: (See Figure V-8A)

1. Check dams should be designed by an engineer. Typical specifications for log and brush check dams are shown in Figure V8-A.
2. Evaluate the gradient of the channel above and below the proposed dam site, prior to installation, to determine if erosion or sediment deposition will be a problem.
3. Locate the check dam in a straight section of the stream, channel, drainage-way, or ditch.
4. Drive 4" - 6" diameter posts into the bed of the channel to a minimum depth of 2 feet.
5. Maximum distance between posts should not exceed 3 feet from centerline to centerline of each post.
6. If using logs and brush, abut several logs against the posts, perpendicular to the flow. Logs should be a maximum of 1 foot apart. Pile brush and logs up behind dam as shown in Figure V-8A.

Maintenance: Check dams should be inspected periodically and repaired if necessary.

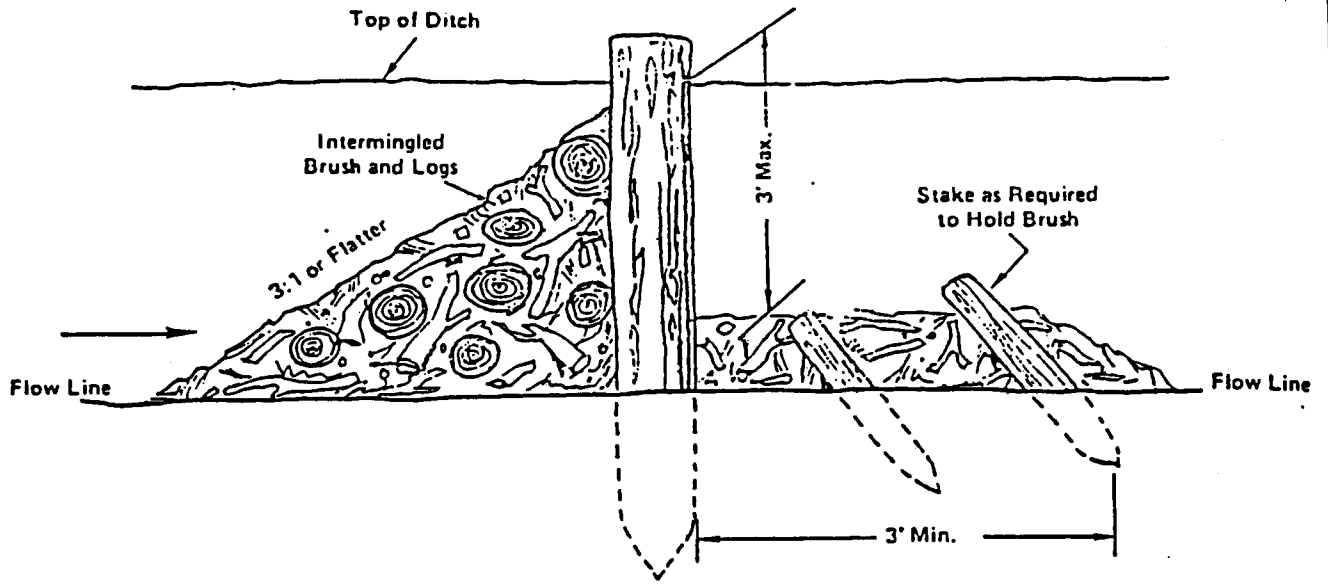

SECTION A-A

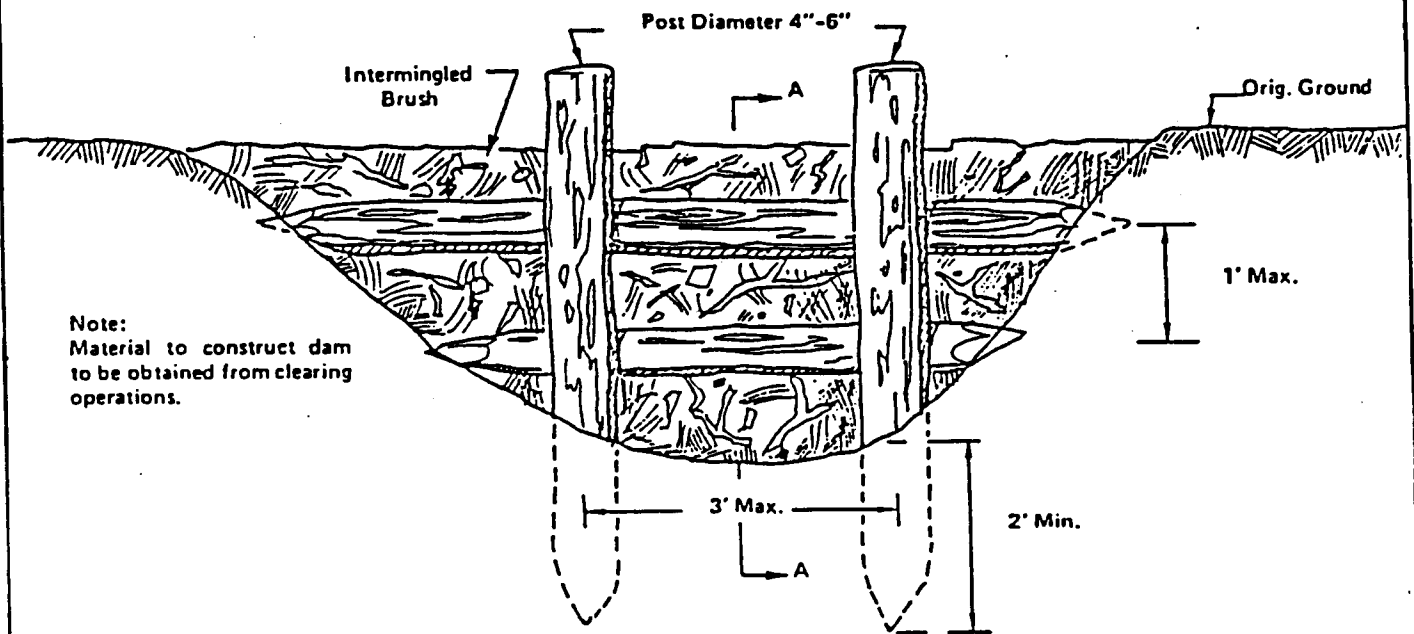

ELEVATION VIEW

LOG AND BRUSH CHECK DAM
FIGURE V-8A

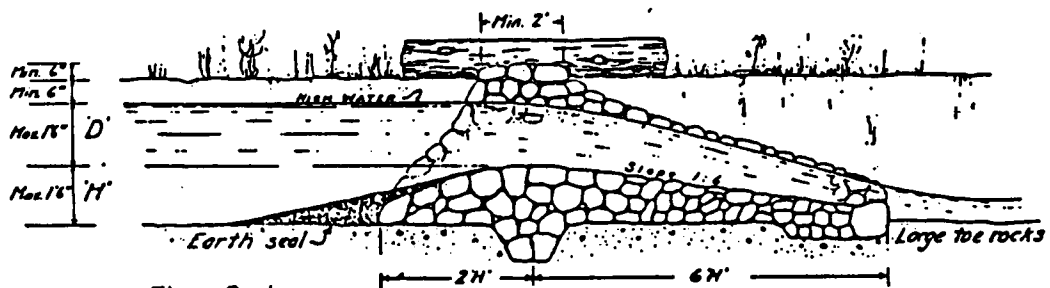
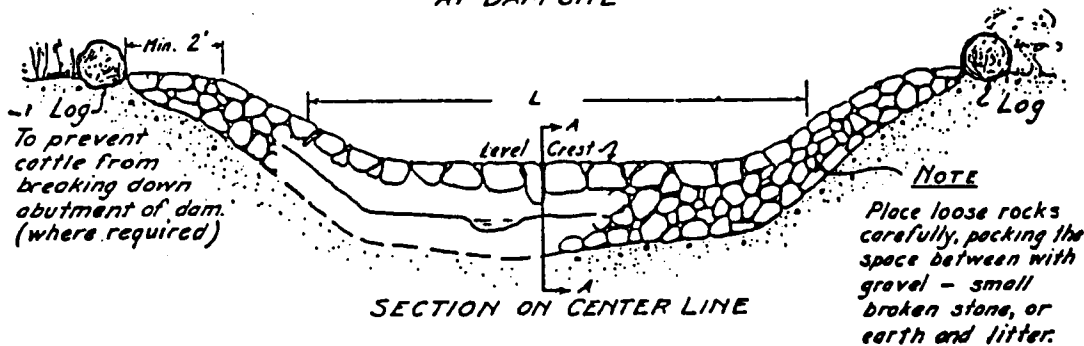
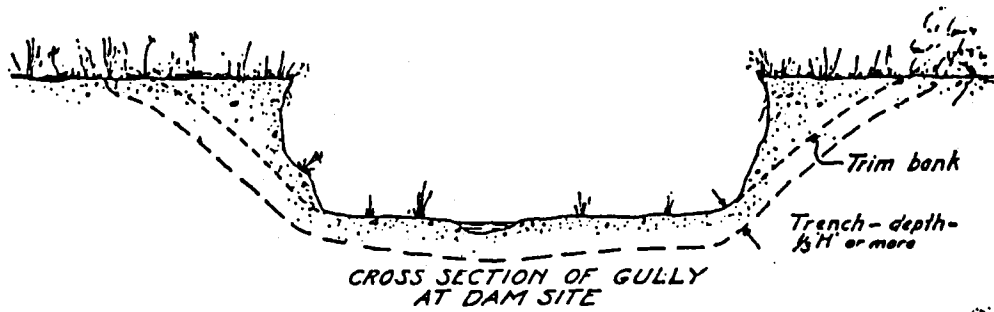

Flow Data

Depth 'D'	Per Ft. of Length L'
0.5 H	1.0 c.f.s.
1.0	3.0
1.5 (Max)	5.5

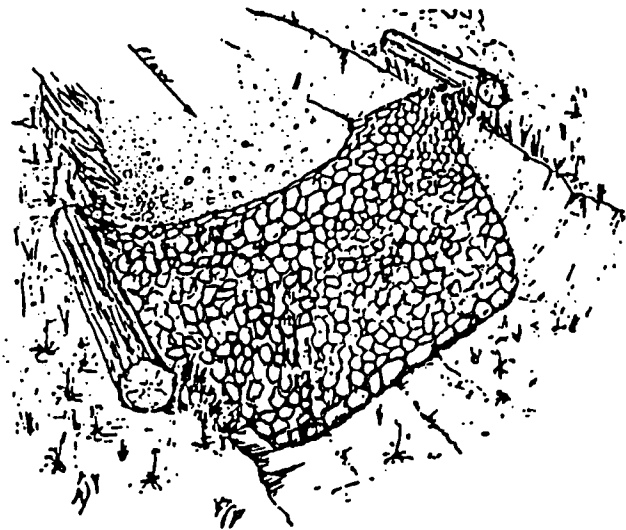
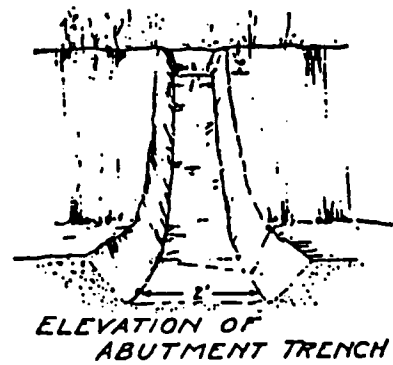

LOOSE ROCK CHECK-DAM
FIGURE V-8B

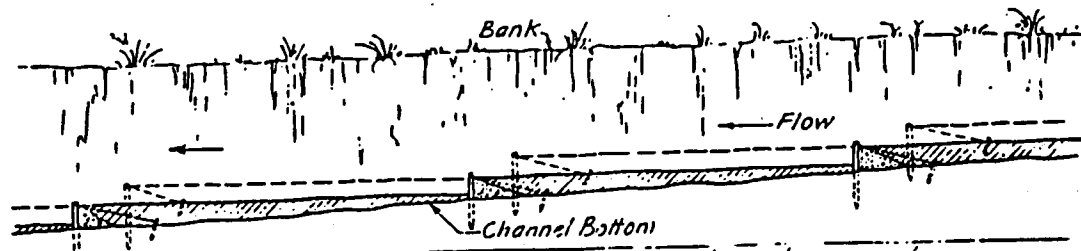

LONGITUDINAL SECTION

After floor of drainage channel is raised to desired height, it should be planted to grass, shrubs or trees to prevent scouring unless controlled by permanent checks.

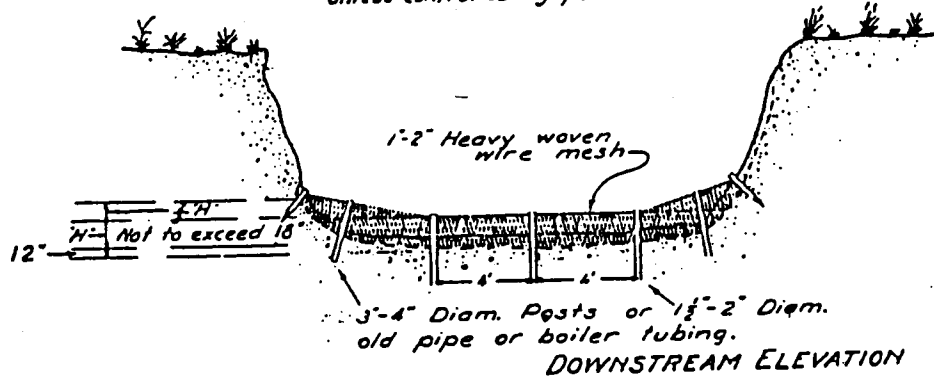

DOWNSTREAM ELEVATION

Set posts firmly, wire or staple mesh securely in place. Make anchor wires tight.

Flow Data

Depth "D"	Per Ft. of Length "L"
0.5 Ft.	1.0 c.f.s.
1.0 "	2.5 "
1.5 "	3.0 "

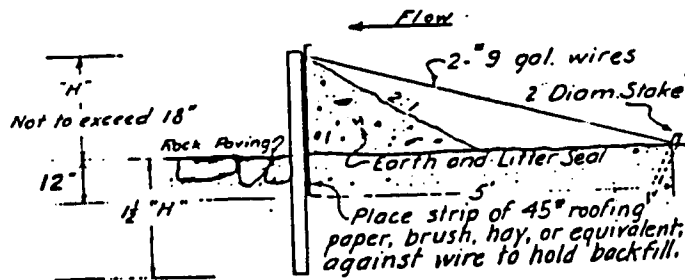
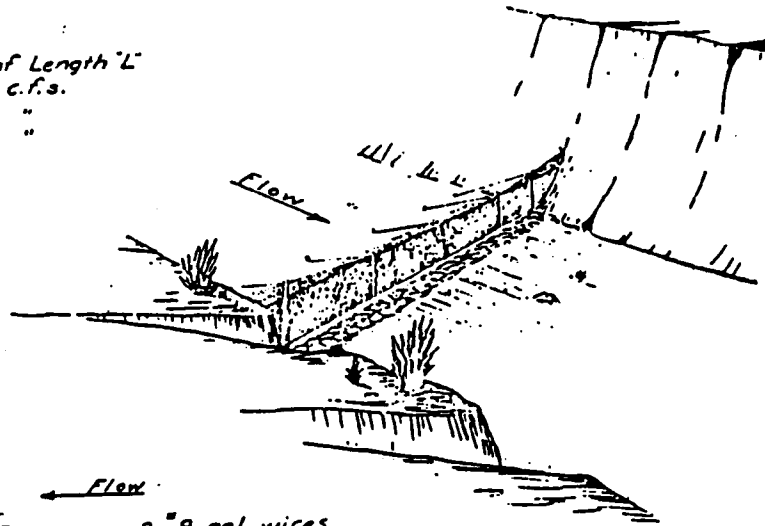

TYPICAL SECTION

INTRODUCTION

The information contained in these appendices is provided to the mining community and state and federal agencies as an information and reference resource only. The Department of Lands cannot guarantee that the techniques and approaches described in the appendices will be effective on a particular mine site, however we hope that the ideas presented here will assist in successfully completing reclamation projects.

In addition, the inclusion of any business name or company in this manual is to be used for reference and information purposes only and should not be construed as an endorsement by the Department of Lands.

EXISTING PROGRAMS AND REGULATORY AUTHORITY

The following section describes existing programs and intergovernmental coordination of key state and federal agencies with authority to issue permits for new mining or mineral processing operations. These agencies also have the authority to require BMP's or measures to control nonpoint sources of pollution from mining and mineral processing operations. Federal agencies are included because a majority of surface mines are located on federal lands. As a result, the federal surface management agency often takes the lead role in administering a permitted activity. Also, Section 319 of the Clean Water Act requires federal consistency with state nonpoint source management programs and provides for state review of federal development projects. This section reflects the regulatory authority as it exists at the present time.

Inquiries concerning any of the following laws or agencies, may be directed to the appropriate field office, shown in the State/Federal Mine Permit Guide. See Appendix B.

MINING AND WATER QUALITY PROTECTING IN IDAHO

A SUMMARY OF STATE LAWS AND REGULATIONS

DEPARTMENT OF LANDS

BUREAU OF MINERALS

**RULES AND REGULATIONS GOVERNING DREDGE AND
PLACER MINING OPERATIONS IN IDAHO**

Title 47 Chapter 13 Idaho Code

SCOPE

These rules apply to all dredge and placer mining or exploration operations conducted within the State, regardless of land ownership.

EXPLORATION OPERATIONS AND REQUIRED RECLAMATION

Any operator desiring to conduct exploration using motorized earth moving equipment shall notify the Department of Lands by certified mail within seven (7) days of beginning the exploration operations. This letter must include the name and address of the operator, a legal description of the exploration operation, starting and estimated completion dates, anticipated size, and general method of operation. This letter shall be treated as confidential in accordance with applicable state laws and regulations. Reclamation shall consist of recontouring and revegetating the affected lands where possible. If the affected lands cannot be recontoured, they must be shaped, graded and revegetated as necessary to ensure that State water quality standards are achieved, or to reestablish the conditions of runoff water quality prior to commencing the exploration operations, whichever is the lesser standard.

APPLICATION REQUIREMENTS AND PROCEDURES

An operator must submit five (5) copies of an application package along with a \$50.00 application fee for each ten acres, or fraction thereof. An application package consists of an application provided by the director, a map or maps of the proposed mining operation which include vicinity maps of the mine area, detailed mine maps which show all aspects of the operation, and a surface and mineral control map of appropriate scale for boundary identification. A reclamation plan must be submitted in map and narrative form which shows the surface profiles before and after mining, all roads which will be reclaimed, a plan for revegetation of the affected lands, reclamation of tailings ponds, and an estimate of total reclamation costs. An operator must also submit a water management plan which identifies and assesses the foreseeable site specific nonpoint sources of water quality impacts upon adjacent surface waters, and the best management practices that the operator will use to control these nonpoint impacts. An out-of-state operator must designate an in-state agent. A complete application should be submitted to the area office for review by the appropriate mineral resource technician.

PROCEDURES FOR REVIEW

The appropriate mineral resource technician or bureau will review all applications for completeness within fourteen days of receipt. Incomplete applications will be returned to the operator within thirty days of the initial application date. Complete applications will be forwarded immediately to the Department of Fish & Game, Division of Environmental Quality and Department of Water Resources. A field review of the proposal will be scheduled with the operator and coordinating agencies. After a field review, a recommendation for approval or denial will be sent to the State Board of Land Commissioners, usually within 90 days of receipt of the application. Public hearings may be required to gather public input on the adequacy of the permit application, environmental impacts, and with respect to water quality protection measures. Annual inspection fees of \$100 on federal lands and \$250 on BLM and private lands.

BONDING

Bonding is required. The reclamation bond shall be the estimated reasonable cost of reclamation required under the plan and the rules for each acre of land which is permitted, plus ten (10%) percent. Acceptable forms of bond include surety, certificate of deposit, cash, and letter of credit.

CLOSURE AND BOND RELEASE

All requests for bond release should be made to the Bureau of Minerals in writing. The Bureau will respond to all requests for bond release within thirty days of receipt of the request. When the operator has completed the required backfilling, regrading, topsoiling and drainage control, sixty (60%) percent of the bond may be released. After revegetation activities have been completed, an additional twenty-five (25%) of the bond will be released. The remaining bond shall be released when all reclamation and fertilization requirements have been met as described in the reclamation plan and the Rules.

IDAHO DEPARTMENT OF LANDS BUREAU OF MINERALS

RULES AND REGULATIONS GOVERNING EXPLORATION AND SURFACE MINING OPERATIONS IN IDAHO

Title 47 Chapter 15 Idaho Code

SCOPE

These rules apply to all surface mining or exploration operations conducted within the State, regardless of land ownership.

EXPLORATION OPERATIONS AND REQUIRED RECLAMATION

Any operator desiring to conduct exploration using motorized earth moving equipment shall notify the Department of Lands by certified mail within seven (7) days of beginning the exploration operations. This letter must include the name and address of the operator, a legal description of the exploration operation, starting and estimated completion dates, anticipated size, and general method of operation. This letter shall be treated as confidential in accordance with applicable state laws and regulations. Reclamation shall consist of recontouring and revegetating the affected lands where possible. If the affected lands cannot be recontoured, they must be shaped, graded and revegetated as necessary to ensure that State water quality standards are achieved, or to reestablish the conditions of runoff water quality prior to commencing the exploration operations, whichever is the lesser standard.

APPLICATION REQUIREMENTS AND PROCEDURES

An operator must submit five (5) copies of a surface mine application package. An application package consists of an application provided by the director, a map or maps of the proposed mining operation which include vicinity maps of the mine area, detailed mine maps which show all aspects of the operation, and a surface and mineral control map of appropriate scale for boundary identification. A reclamation plan must be submitted in map and narrative form which shows the surface profiles before and after mining, all roads which will be reclaimed, a plan for revegetation of the affected lands, reclamation of tailings ponds, and an estimate of total reclamation costs. An operator must also submit a water management plan which identifies and assesses the foreseeable site specific nonpoint sources of water quality impacts upon adjacent surface waters, and the best management practices that the operator will use to control these nonpoint impacts. A complete reclamation plan application should be submitted to the area office for review by the appropriate mineral resource technician.

PROCEDURES FOR REVIEW

The appropriate mineral resource technician or bureau will review all applications for completeness within fourteen days of receipt. Incomplete applications will be returned to the operator within thirty days of the initial application date. Complete applications will be forwarded immediately to the Department of Fish & Game, Division of Environmental Quality and Department of Water Resources. A field review of the proposal will be scheduled with the operator and coordinating agencies. After a field review, a recommendation for approval or denial will be sent to the director. An notice of approval or denial will be sent to the applicant within 60 days of the application date. Public hearings may be required to gather public input on the adequacy of the permit application, environmental impacts, and with respect to water quality protection measures.

BONDING

Bonding is required. The reclamation bond shall be the estimated cost of reclamation for each acre of land which is permitted. Acceptable forms of bond include surety, certificate of deposit, cash, and letter of credit.

CLOSURE AND BOND RELEASE

All requests for bond release should be made to the Bureau of Minerals in writing. The Bureau will respond to all requests for bond release within thirty days of receipt of the request. When the operator has completed the required backfilling, regrading, topsoiling and drainage control, sixty (60%) percent of the bond may be released. After revegetation activities have been completed, an additional twenty-five (25%) of the bond will be released. The remaining bond shall be released when all reclamation and fertilization requirements have been met as described in the reclamation plan and the Rules.

DEPARTMENT OF HEALTH & WELFARE

Mining and milling operations in Idaho are required to comply with the Environmental Protection and Health Act of 1972 (Idaho Code title 39). The policy of the Act is "to provide for the protection of the environment and the promotion of personal health and to thereby protect and promote the health, safety, and general welfare of the people of this state."

Water pollution control requirements are administered by the Department of Health and Welfare (IDHW), Division of Environmental Quality.

Water pollution control requirements in Idaho are also sanctioned under the Federal Waste Pollution Control Act. This law is administered by the U.S. Environmental Protection Agency (EPA) in cooperation with the IDHW.

1. Water Quality Standards. (Idaho Code title 39, section 101)

All waters of the state are protected for appropriate beneficial uses. Specific standards and designated uses for the waters of the state are defined in Idaho Water Quality Standards and Wastewater Treatment Requirements.

2. Review of Plans and Specifications for Wastewater Treatment Facilities. (Idaho Code title 39, section 118)

All plans and specifications for new and/or modified wastewater collection or treatment facilities must be approved by IDHW before construction of the facilities may begin. This requirement applies to mine and mill wastewater treatment facilities and tailings impoundments regardless of whether the facility discharges to state waters or is self-contained.

3. Ore Processing by Cyanidation. (Idaho Code title 39, section 118A)

All plans and specifications must be submitted to and approved by IDHW. All plans and specifications must be certified by registered professional engineers. Rules and regulations are available through IDHW.

4. Federal Clean Water Act. (section 319)

Amendments passed in 1987 called for implementation of non-point source programs to improve water quality in degraded streams. The Idaho Nonpoint Source Assessment and Nonpoint Source Management Program were completed in 1989. IDHW is the designated state agency for implementation of this program.

5. National Pollutant Discharge Elimination System (NPDES).

EPA is responsible for issuance and enforcement of NPDES permits under the authority of Section 402, FWPCA. For specific mining effluent requirements, you must contact the EPA. IDHW assists EPA by determining discharge limitations (treatment requirements) according to the water quality standards of the receiving waters (see #1). In some cases, the discharge may not be allowed if the standards cannot be met. An NPDES permit is required for any point source discharge to surface water, including mine drainage water and mine and mill wastewater.

Inquiries concerning these laws may be directed to the field offices shown on the attached map.

DEPARTMENT OF WATER RESOURCES

The Idaho Department of Water Resources administers three (3) statutes under Idaho law which directly or indirectly affect mining and milling activities. The statutes include water right appropriations, the Stream Channel Alteration Act and the Safety of Dams Act. Inquiries concerning these laws may be directed to the following regional offices:

NORTHERN REGION

Idaho Dept. of Water Resources
1920 Northwest Boulevard, #210
Coeur d'Alene, Idaho 83814

WESTERN REGION

Idaho Dept. of Water Resources
2735 Airport Way,
Statehouse Mail
Boise, Idaho 83705

SOUTHERN REGION

Idaho Dept. of Water Resources
222 Shoshone Street East
Twin Falls, Idaho 83301

EASTERN REGION

Idaho Dept. of Water Resources
150 Shoup Avenue, Suite 15
Idaho Falls, Idaho 83401

1. Water Appropriation. (Idaho Code title 42, chapter 2)

Any diversion and appropriation of water from the public waters of Idaho must be authorized by a water right permit.

2. The Stream Channel Alteration Act. (Idaho Code title 42, chapter 38)

The law requires that stream channels of the state and their environments be protected against alteration for the protection of fish and wildlife habitat, aquatic life, recreation, aesthetic beauty, and water quality. An alteration is defined as any activity which obstructs, diminishes, destroys, alters, modifies, relocates or changes the natural existing shape or direction of water flow of any stream channel within or below the mean high water mark. The law provides that any project or activity which will alter a stream channel cannot be undertaken without authorization from the Department of Water Resources in the form of a permit. The permit process and minimum standards are described in Rules and Regulations and Minimum Standards for Stream Channel Alterations. Rules and regulations are available through IDWR.

3. Safety of Dams. (Idaho Code title 42, chapter 17)

The Dam Safety Act includes mine tailings impoundment structures and water storage dams. Through this act it was the intent of the legislature "to provide for the regulation of construction, maintenance and operation of all dams, reservoirs and mine tailing impoundment structures . . . to the extent required for the protection of the public safety". A mine tailing impoundment is defined as "any artificial embankment which is or will be more than thirty (30) feet in height measured from the lowest elevation of the toe to the maximum crest elevation . . ." A water storage dam is defined as an artificial barrier which is or will be ten (10) feet or more in height or has or will have an impounding capacity of fifty (50) acre-feet or more.

The Department of Water Resources is authorized to review and approved plans and specifications for mine tailing impoundments and water storage dams in order to inspect such facilities during both construction and operation for integrity and safety. Rules and regulations for both mine tailings impoundment structures and safety of dams have been adopted and are available upon request from IDWR.

Inquiries concerning these laws may be directed to any of the regional offices as shown on the attached maps.

**GUIDE TO STATE AND FEDERAL
PERMITS FOR MINING
RELATED PROJECTS WITHIN
THE STATE OF IDAHO**

This guide is intended to provide information regarding key agency contacts and environmental permits needed to develop a mining operation.

This guide is not intended to be a total listing of required permits. Laws and regulations may change and other requirements which are not addressed may be applicable. If you do not understand exactly what is required, contact the specific agency or agencies involved with your project.

To use this guide effectively, determine whether you will be operating on land administered by the U.S. Forest Service, Bureau of Land Management, Idaho Department of Lands or on private land. After determining land ownership, review the major headings at the top of each page. You must also review the section titled MISCELLANEOUS PERMIT REQUIREMENTS.

Based on land ownership, determine which activity description applies to your operation, then review that section to obtain specific information regarding permits, agency contact, and general information. Agency contacts, telephone numbers, and locations are provided at the end of this guide.

For questions of land ownership, contact the local county courthouse, State Office of the Bureau of Land Management and the Idaho Department of Lands.

Within this document, the following abbreviations will be used:

BLM -- Bureau of Land Management

COE -- U.S. Army Corps of Engineers

DEQ -- Dept. of Health and Welfare, Division of Environmental Quality

EPA -- U.S. Environmental Protection Agency

IDL -- Idaho Department of Lands

IDWR -- Idaho Department of Water Resources

USFS -- U.S. Forest Service

USFWS -- U.S. Fish and Wildlife Service

NMFS -- National Marine Fisheries Service

**MINING OR EXPLORATION ON LANDS ADMINISTERED BY THE
BUREAU OF LAND MANAGEMENT**

**ACTIVITY: EXPLORATION OPERATIONS AFFECTING LESS THAN FIVE
ACRES**

Type of Permit: BLM Notice of Intent
IDL Notice of Exploration or Placer Permit

Agency Contact: Minerals specialist at the appropriate BLM district office (Map No. 5).
Mineral resource technician at appropriate IDL area office (Map No. 3).

Gen. Information: A complete notice must be submitted to the appropriate BLM District Office 15 days
prior to commencing operations (see 43 CFR 3809.1-6), and;

IDL requires a notice be submitted to the state or appropriate area office within 7
days of beginning exploration. Placer exploration exceeding 1/2 acre requires a
permit; 60-90 day review, \$50.00 application fee/10 acres, bond required.

ACTIVITY: MINING OPERATIONS AFFECTING LESS THAN 5 ACRES

Type of Permit: BLM Notice of Intent
IDL Reclamation Plan or Placer Permit

Agency Contact: Mineral specialist at the appropriate BLM district office (Map No. 5). Mineral
resource technician at appropriate IDL area office (Map No. 3).

Gen. Information: A complete notice must be submitted to the appropriate BLM district office 15 days
prior to commencing operations (see 43 CFR 3809.1-6), and IDL requires a
reclamation plan or placer permit. Allow 60 days for IDL reclamation plan approval;
no fees, bond required. Allow 60 to 90 days for placer permitting; \$50.00 application
fee/10 acres, bond required.

ACTIVITY: MINING OR EXPLORATION AFFECTING MORE THAN 5 ACRES

Type of Permit: BLM Plan of Operation
IDL Reclamation Plan or Placer Permit.

Agency Contact: Mineral specialist at the appropriate BLM district office (Map No. 5). Mineral
resource technician at appropriate IDL area office (Map No. 3).

Gen. Information: Plan of operation must be submitted to BLM district office; 30 day review period.
Operations may not begin without an approved plan (see 43 CFR 3809.1-6) and IDL
requires a reclamation plan or placer permit. Allow 60 days for IDL reclamation
plan approval; no fees, bond required. Allow 60 to 90 days for placer permitting;
\$50.00 application fee/10 acres, bond required.

MINING OR EXPLORATION ON NATIONAL FOREST SYSTEM LANDS

ACTIVITY: **NON-MECHANIZED EXPLORATION**

Type of Permit: No notice required
 No notices or permits required by IDL

Agency Contact: Minerals specialist at appropriate National Forest (Table No. 1).

Gen. Information: A complete notice must be submitted to the appropriate Ranger District prior to commencing operations. Operator will be notified within 15 days if a plan of operation is required (see 36 CFR 228.4).

ACTIVITY: **MECHANIZED EXPLORATION**

Type of Permit: Plan of Operation with USFS
 IDL Notice of Exploration

Agency Contact: Minerals specialist at appropriate National Forest (Table No. 1).
 Mineral resource technician at appropriate IDL area office (Map No. 3).

Gen. Information: For the Forest Service, a plan of operation must be filed with appropriate Ranger District before operations begin; 30 day review period with extensions if necessary (see 36 CFR 228.4).

IDL requires an operator to submit to them a copy of the Forest Service plan of operation. Surface exploration exceeding 5 acres, or 10 non-contiguous acres, requires a reclamation plan; 60 day review, bond required. Placer exploration exceeding 1/2 acre requires a permit; 60-90 day review, \$50.00 application fee/10 acres, bond required.

ACTIVITY: **MINING OPERATIONS**

Type of Permit: Plan of Operation with USFS
 IDL Reclamation Plan or Placer Permit

Agency Contact: Minerals specialist at the appropriate National Forest (Table No. 1).
 Mineral resource technician at appropriate IDL area office (Map No. 3).

Gen. Information: For the Forest Service, a plan of operation must be filed with appropriate Ranger District before operations begin; 30 day review period with extensions if necessary (see 36 CFR 228.4), and a reclamation plan or placer permit is required by IDL.

IDL reclamation plan approval allows 60 days; no fees, bond required. Allow 60 to 90 days for placer permitting; \$50.00 application fee/10 acres, bond required.

MINING OR EXPLORATION ON PRIVATE LANDS

ACTIVITY

EXPLORATION

Type of Permit:

IDL Notice of Exploration

Agency Contact:

Mineral resource technician at appropriate IDL area office (Map No. 3).

Gen. Information:

IDL requires an exploration notice be filed with the appropriate office within 7 days of commencing motorized operations. Placer exploration that exceeds 1/2 acre, including access roads, must obtain a placer permit; 60-90 day review, \$50.00 application fee/10 acres, bond required. Surface exploration that exceeds 5 contiguous, or 10 non-contiguous, acres must obtain a reclamation plan. See MINING CONDUCTED ON PRIVATE LANDS

ACTIVITY:

MINING

Type of Permit:

IDL Placer Permit
IDL Reclamation Plan

Agency Contact:

Mineral resource technician at appropriate IDL area office (Map No. 3).

Gen. Information:

IDL approves surface mine reclamation plans within 60 days, weather permitting; no fee required, bonding required not to exceed \$1800.00 per affected acre. IDL approves placer mine permits within 60-90 days, weather permitting; \$50.00 application fee/10 acres, bonding required for actual cost of reclamation.

MINING OR EXPLORATION ON IDAHO STATE LANDS OR RIVERBEDS

ACTIVITY: CASUAL EXPLORATION ON IDAHO STATE LANDS

Type of Permit: No permitting necessary; optional lease or location

Agency Contact: Mineral leasing specialist at IDL state office (Map No. 3).
Mineral resource technician at appropriate IDL area office (Map No. 3).

Gen. Information: All state-owned lands not withdrawn, leased, or located are open for casual exploration without a permit from IDL. IDL does not require a permit for casual exploration on state-owned lands not withdrawn, leased or located.

ACTIVITY: CASUAL/RECREATIONAL EXPLORATION ON NAVIGABLE RIVERS

Type of Permit: No permitting necessary; optional lease or location.
See MISCELLANEOUS PERMITS -- IDWR.

Agency Contact: Mineral leasing specialist at IDL state office (Map No. 3).
Mineral resource technician at appropriate IDL area office (Map No. 3).

Gen. Information: All navigable rivers not withdrawn, leased, or located are open for casual/recreational exploration without a permit from IDL. IDL does not require a permit for casual exploration/recreational mining on navigable rivers not withdrawn, leased or located.

ACTIVITY: MOTORIZED EXPLORATION/MINING ON IDAHO STATE LANDS

Type of Permit: Mineral Location or Mineral Lease and written approval of exploration or operating/reclamation plan.

Agency Contact: Mineral leasing specialist at IDL state office (Map No. 3).
Mineral resource technician at appropriate IDL area office (Map No. 3).

Gen. Information: IDL requires an approved mineral location or lease application with fees, rents, and bonds, prior to conducting motorized exploration or mining Idaho state lands. Exploration/operation activity requires 60 days advance notice, no fees, bond may be required.

ACTIVITY: MOTORIZED EXPLORATION/MINING ON NAVIGABLE RIVERS

Type of Permit: Mineral Lease and written approval of exploration or operation plan and IDL Placer Permit, if using a suction dredge with an intake larger than eight (8) inches, or motorized equipment.
See MISCELLANEOUS PERMITS -- IDWR

Agency Contact: Mineral leasing specialist at IDL state office (Map. No. 3).
Mineral resource technician at appropriate IDL area office (Map No. 3).

Gen. Information: Approved lease document required with appropriate fees, rents, and bonds. Exploration/mining activity requires 60 days advance notice, no fees, bonds required.

MISCELLANEOUS PERMIT REQUIREMENTS

ACTIVITY: OPERATION OF A SUCTION DREDGE WITH NOZZLE INTAKE DIAMETER OF EIGHT (8) INCHES OR SMALLER.

Type of Permit: IDWR Stream Channel Alteration Permit.
Agency Contact: Stream protection specialist at appropriate IDWR regional office (Map No. 2).
Gen. Information: Nozzle diameter of five (5) inches or less -- one stop recreational permit, good for year issued.
Nozzle diameter of more than five (5) inches -- joint state-federal stream channel alteration permit; review time based on complexity of the project.

ACTIVITY: OPERATION OF A SUCTION DREDGE WITH NOZZLE INTAKE DIAMETER LARGER THAN EIGHT (8) INCHES

Type of Permit: Joint State-Federal Stream Channel Alteration Permit.
IDL Placer Mine Permit.
Agency Contact: Stream protection specialist at appropriate IDWR office (Map No. 2).
Mineral resource technician at appropriate IDL area office (Map No. 3).
Gen. Information: Stream channel alteration permit application review time based on complexity of permit. IDL requires 60 - 90 days for issuance of placer permit; \$50.00 application fee/10 acres, bond required.

ACTIVITY: USE OF SURFACE OR GROUND WATER IN MINING OR EXPLORATION OPERATION

Type of Permit: IDWR Water Right
Agency Contact: Water rights resource agent at appropriate IDWR regional office (Map No. 2).
Gen. Information: IDWR appropriation application review activity requires 6-8 weeks providing the application is not protested; fee based on rate of diversion. A groundwater construction permit is required to drill a well.

ACTIVITY: MINING, EXPLORATION AND RELATED ACTIVITIES CONDUCTED WITHIN THE HIGHWATER MARK OF A STREAM CHANNEL OR OPERATIONS AFFECTING SURFACE WATERS

Type of Permit: IDWR Stream Channel Alteration Permit
Agency contact: Stream protection specialist at appropriate IDWR office (Map No. 2).
Gen. Information: Joint state/federal stream channel alteration permit required; review time based on complexity of project.

MISCELLANEOUS PERMIT REQUIREMENTS

ACTIVITY: STORM-WATER WHICH CONTACTS RAW, INTERMEDIATE, OR FINAL PRODUCTS; OR WASTE MATERIAL/PROCESS WASTE; OR PROCESS WATER WHICH DISCHARGES TO SURFACE WATERS

Type of Permit: EPA 402 Permit (National Pollutant Discharge Elimination System Permit)

Agency Contact: Environmental Protection Agency, Attention: Appropriate Agent, 422 West Washington, Boise, Idaho 83702, telephone (208) 334-9505 (Map No. 6). Also contact the stream channel protection specialist at appropriate IDWR regional office (Map No. 2).

Gen. Information: Application must be made 180 days prior to discharge; no fees.

ACTIVITY: LAND APPLICATION OF MINE OR MILL WASTEWATER

Type of Permit: No permit; approval from the Department of Health and Welfare, Division of Environmental Quality

Agency Contact: Appropriate area office of DEQ (Map No. 1).

Gen. Information: Groundwater monitoring for water quality required. DEQ will review plans to ensure compliance with water quality standards.

ACTIVITY: DISCHARGE OF DREDGED OR FILL MATERIAL INTO WETLANDS OR BELOW THE ORDINARY HIGHWATER MARK OF ANY SURFACE WATER.

Type of Permit: Army Corps of Engineers 404 Permit

Agency Contact: Appropriate COE office (Map No. 6).

Gen. Information: Permit review times vary depending on complexity of project. Unavoidable impacts to wetlands must be mitigated.

ACTIVITY: USE OF CYANIDE IN MINERAL RECOVERY, MINING, OR EXPLORATION OPERATIONS

Type of Permit: DEQ Cyanidation Permit

Agency Contact: Appropriate DEQ area office (Map No. 1).

Gen. Information: Application fee of \$100.00; 4-6 month permit review process, minimum \$25,000.00 bond required. On public lands it is advisable to submit an application after an environmental assessment or draft environmental impact statement has been completed.

AGENCIES REQUIRING REVIEW, COMMENT OR CONSULTATION

ACTIVITY: **CONSTRUCTION OF SEWAGE OR WASTEWATER TREATMENT FACILITIES**

Type of Permit: No permit; review of design plans and specifications is authorized under Idaho Code title 39, chapter 118.

Agency Contact: Appropriate DEQ area office (Map No. 1).

Gen. Information: No fee; environmental review and approval of plans and specifications are coordinated, when applicable, with dam safety reviews by the IDWR. Plans and specifications are reviewed by a DEQ engineer before construction. With some exceptions, the plans must be certified by an engineer licensed to practice in Idaho.

For placer mining, information provided under Rule 021 of the Rules Governing Placer and Dredge Mining Operations in Idaho will provide adequate information for DEQ review.

ACTIVITY: **REGIONS WHERE THREATENED OR ENDANGERED SPECIES MAY BE IMPACTED BY ANY ACTIVITY MINING RELATED.**

Type of Permit: No permit; National Marine Fisheries Service (NMFS) has a mandate to conserve and restore populations and critical habitat for Snake River salmon listed under the Endangered Species Act (ESA) and to conserve and enhance populations of other anadromous fishes such as steelhead. NMFS's primary authorities for related actions in Idaho include the ESA, Fish and Wildlife Coordination Act (FWCA), Clean Water Act (CWA), and the National Environmental Policy Act (NEPA). The U.S. Fish and Wildlife Service (USFWS) also has authorizations and mandates specified under the ESA, FWCA, CWA, and NEPA as well as the Migratory Bird Treaty Act. Generally, anadromous fish and their supporting habitat responsibilities rest with NMFS, and the USFWS is responsible for ensuring that federal activities include appropriate consideration of resident fish and wildlife and their habitats.

Agency Contact: National Marine Fisheries Service and the U.S. Fish and Wildlife Service both maintain field offices in Boise, Idaho.

Gen. Information: No fee; the agencies' authorities and responsibilities are met through participation in the NEPA analysis of proposed plans and the FWCA review and conditioning of Corps of Engineers and EPA permits. All federal agencies are required to consult with NMFS or USFWS to ensure that actions undertaken or permitted by their agency will be consistent with the provisions of the ESA. Private sector actions that require a federal permit must be coordinated through the permitting (action) agency to ensure that the act of enabling the action through a federal permit complies with ESA requirements. Most project proposals can be modified or the enabling permits conditioned to meet the mandated resource concerns of NMFS and USFWS.

IDAHO DEPARTMENT OF HEALTH AND WELFARE
 DIVISION OF ENVIRONMENTAL QUALITY
 WATER QUALITY FIELD OFFICES

Map #1

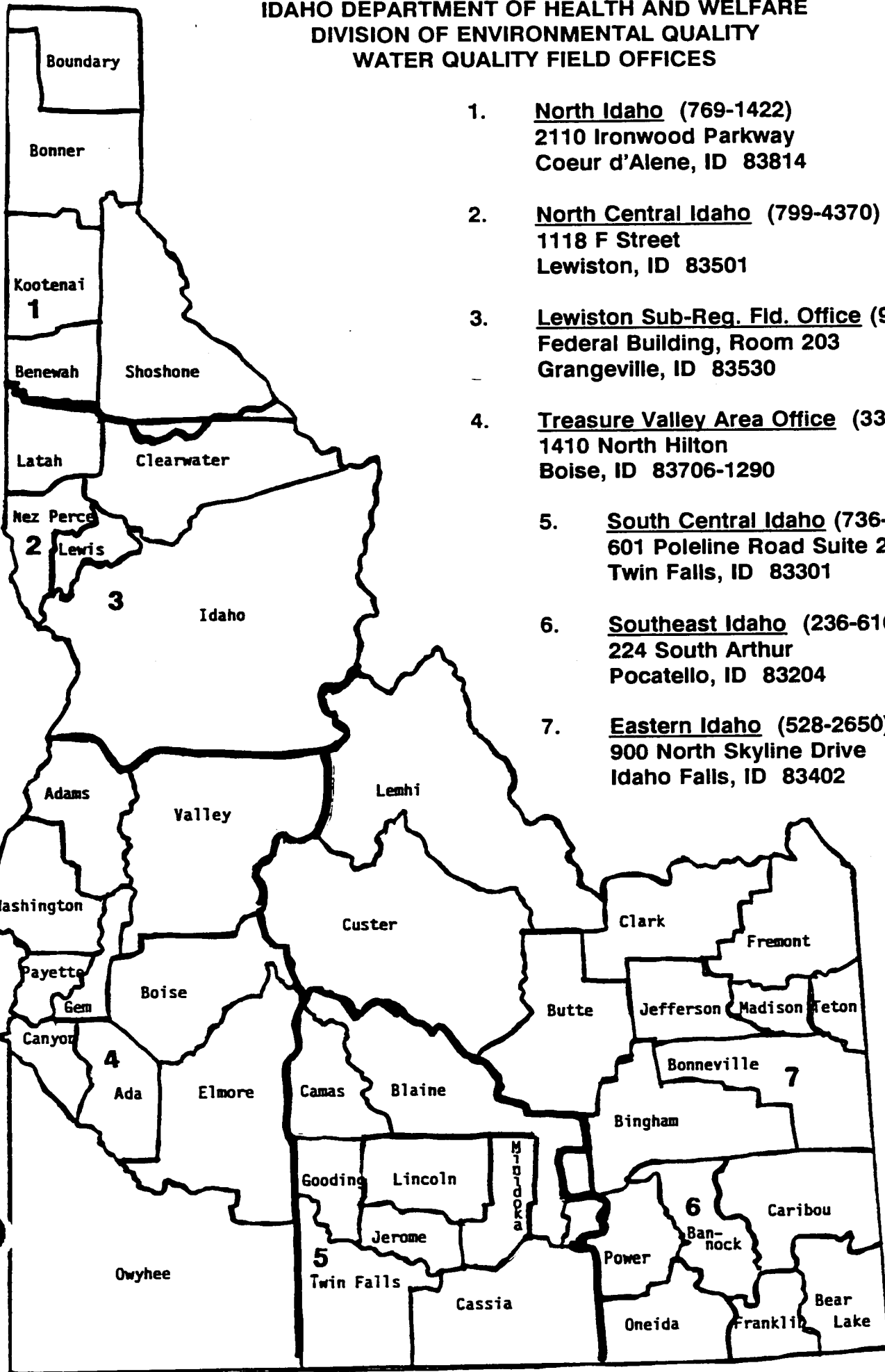

1. North Idaho (769-1422)
 2110 Ironwood Parkway
 Coeur d'Alene, ID 83814
2. North Central Idaho (799-4370)
 1118 F Street
 Lewiston, ID 83501
3. Lewiston Sub-Reg. Fld. Office (983-0808)
 Federal Building, Room 203
 Grangeville, ID 83530
4. Treasure Valley Area Office (334-0502)
 1410 North Hilton
 Boise, ID 83706-1290
5. South Central Idaho (736-2190)
 601 Poleline Road Suite 2
 Twin Falls, ID 83301
6. Southeast Idaho (236-6160)
 224 South Arthur
 Pocatello, ID 83204
7. Eastern Idaho (528-2650)
 900 North Skyline Drive
 Idaho Falls, ID 83402

IDAHO DEPARTMENT OF WATER RESOURCES
REGIONAL OFFICES AND CONTACT PERSONS FOR
STREAM CHANNEL ALTERATION PERMITS

Map #2

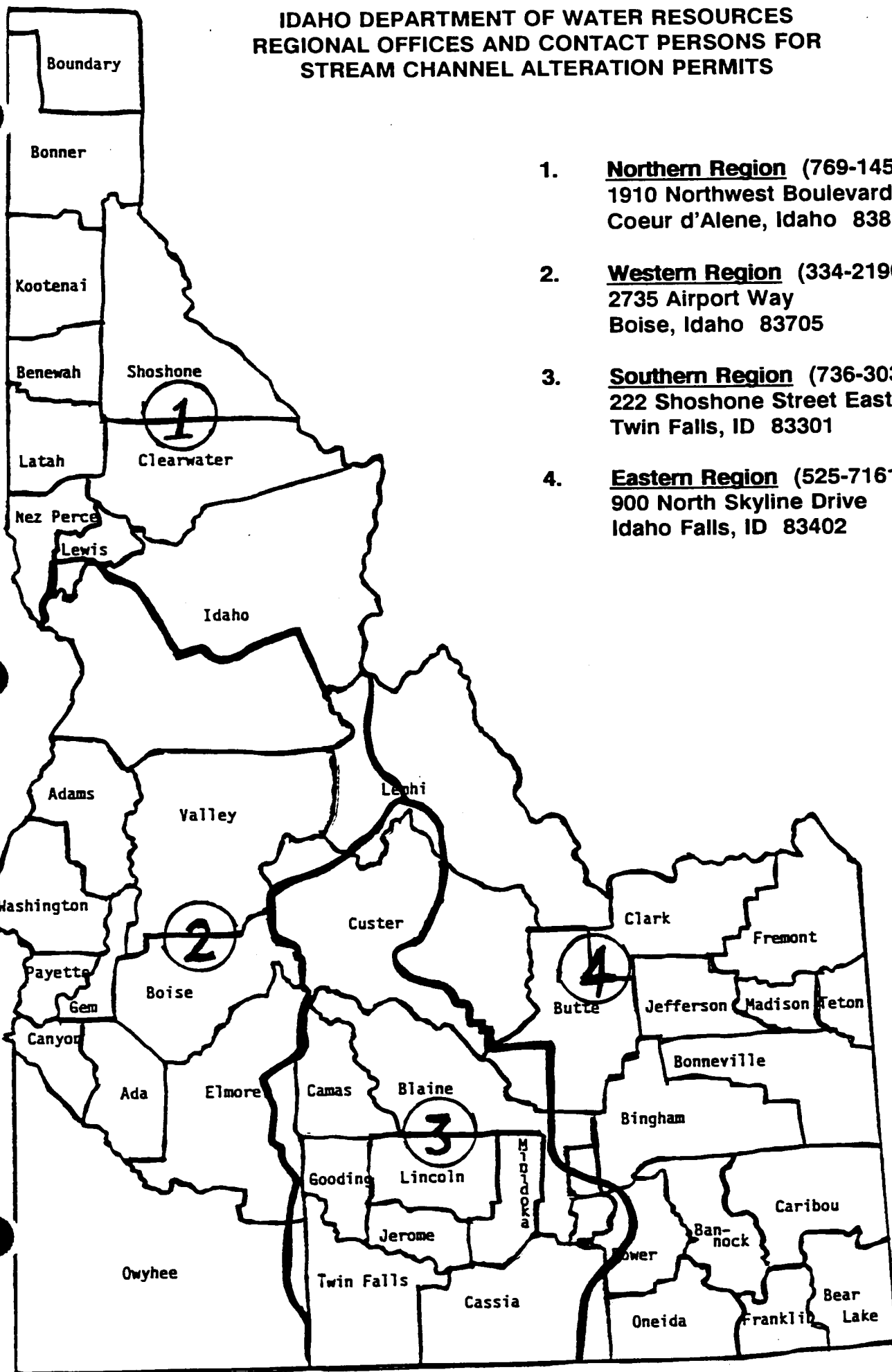

1. **Northern Region** (769-1459)
1910 Northwest Boulevard, #210
Coeur d'Alene, Idaho 83814
2. **Western Region** (334-2190)
2735 Airport Way
Boise, Idaho 83705
3. **Southern Region** (736-3033)
222 Shoshone Street East
Twin Falls, ID 83301
4. **Eastern Region** (525-7161)
900 North Skyline Drive
Idaho Falls, ID 83402

IDAHO DEPARTMENT OF LANDS
Mineral Regulatory Areas

1. PRIEST LAKE (443-2516)
Route 1, Box 284
Coolin, ID 83821
 2. PEND ORIELLE LAKE (263-5104)
P.O. Box 909
Sandpoint, Idaho 83834
 3. ST. JOE (245-4551)
1806 Main Avenue
St. Maries, Idaho 83861
- PLACER MINING IN AREAS 1, 2 AND 3 (765-5235)
MINERAL RESOURCES TECH, AREAS 1, 2, 3
1910 Northwest Blvd., Suite 101
Coeur d'Alene, Idaho 83814
4. CLEARWATER (476-4587)
MINERAL RESOURCES TECH.
10230 Highway 12
Orofino, Idaho 83544
 5. PAYETTE LAKES (634-7125)
MINERAL RESOURCES TECH
P.O. Box AS
McCall, Idaho 83638
 6. SOUTHWESTERN (334-3488)
MINERAL RESOURCES TECH, AREAS 6, 7
8355 West State Street
Boise, ID 83703
 7. SOUTH CENTRAL (934-5606)
P.O. Box 149
Gooding, Idaho 83330
 8. EASTERN (523-5398)
MINERAL RESOURCE TECHNICIAN
Route 1, Box 400
Idaho Falls, Idaho 83401

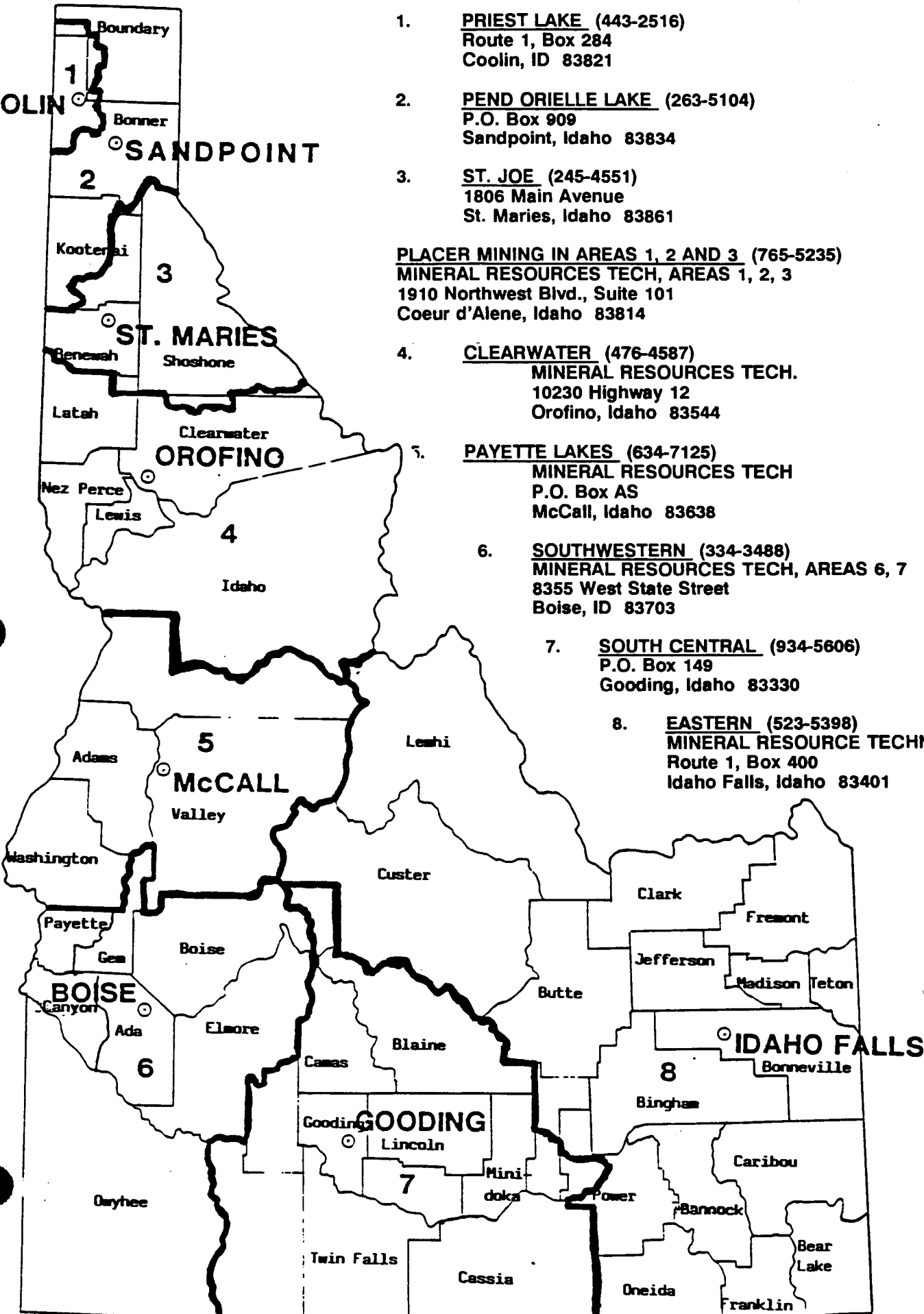

IDAHO DEPARTMENT OF FISH AND GAME
REGIONAL OFFICES

Map #4

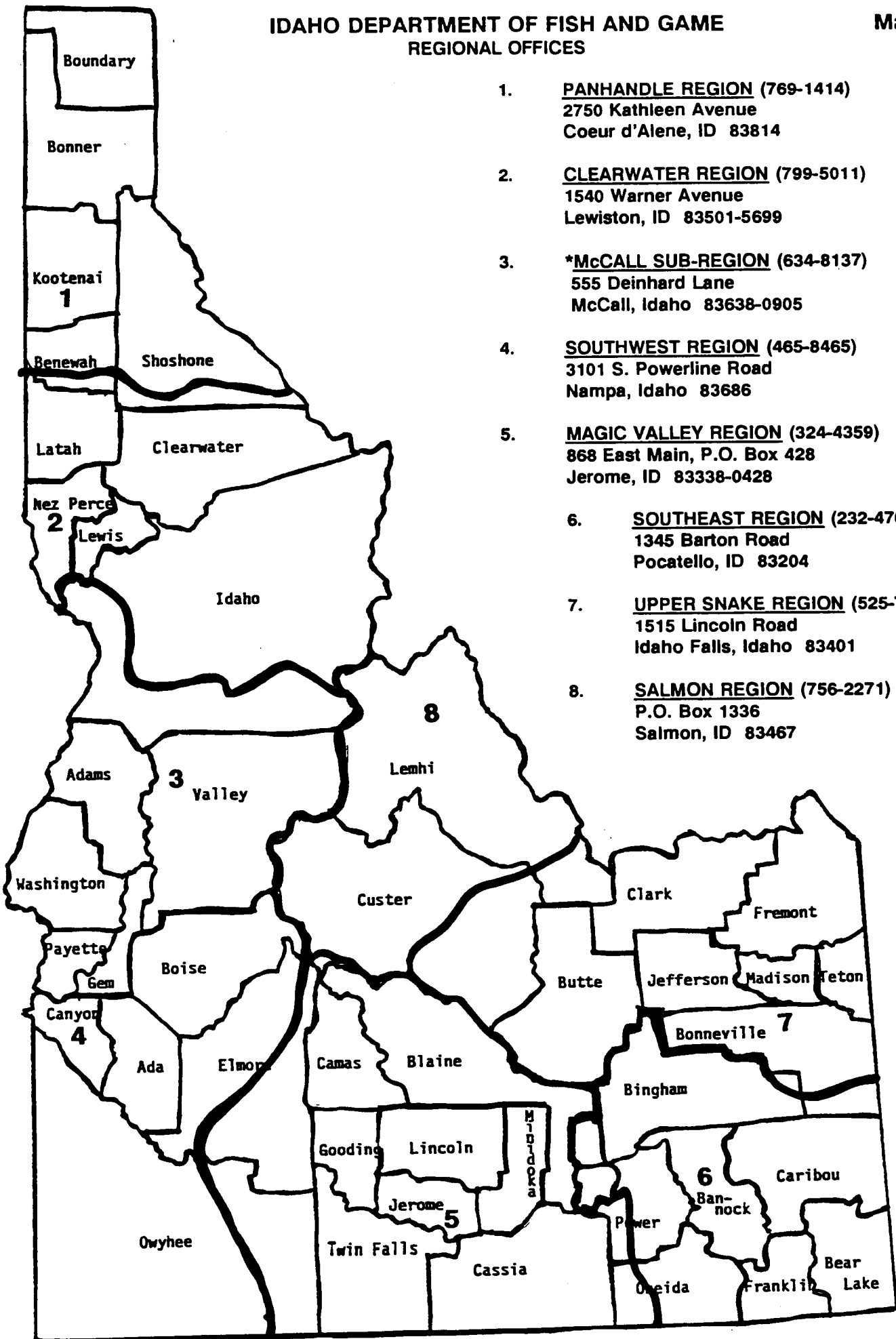

1. PANHANDLE REGION (769-1414)
2750 Kathleen Avenue
Coeur d'Alene, ID 83814
2. CLEARWATER REGION (799-5011)
1540 Warner Avenue
Lewiston, ID 83501-5699
3. *McCALL SUB-REGION (634-8137)
555 Deinhard Lane
McCall, Idaho 83638-0905
4. SOUTHWEST REGION (465-8465)
3101 S. Powerline Road
Nampa, Idaho 83686
5. MAGIC VALLEY REGION (324-4359)
868 East Main, P.O. Box 428
Jerome, ID 83338-0428
6. SOUTHEAST REGION (232-4703)
1345 Barton Road
Pocatello, ID 83204
7. UPPER SNAKE REGION (525-7290)
1515 Lincoln Road
Idaho Falls, Idaho 83401
8. SALMON REGION (756-2271)
P.O. Box 1336
Salmon, ID 83467

BUREAU OF LAND MANAGEMENT
DISTRICT OFFICES

Map #5

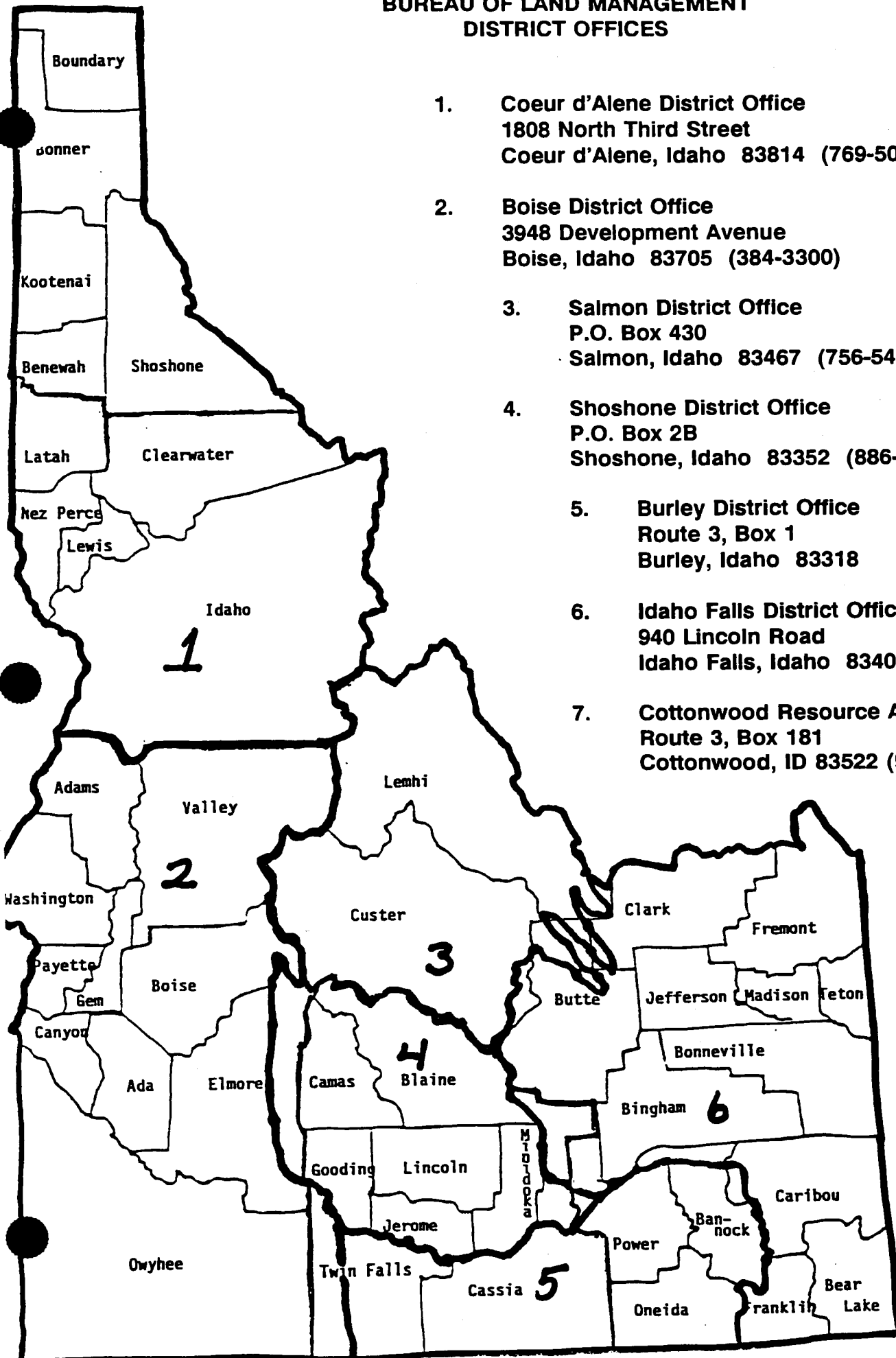

1. **Coeur d'Alene District Office**
1808 North Third Street
Coeur d'Alene, Idaho 83814 (769-5000)
2. **Boise District Office**
3948 Development Avenue
Boise, Idaho 83705 (384-3300)
3. **Salmon District Office**
P.O. Box 430
Salmon, Idaho 83467 (756-5400)
4. **Shoshone District Office**
P.O. Box 2B
Shoshone, Idaho 83352 (886-2206)
5. **Burley District Office**
Route 3, Box 1
Burley, Idaho 83318 (678-5514)
6. **Idaho Falls District Office**
940 Lincoln Road
Idaho Falls, Idaho 83401 (524-7500)
7. **Cottonwood Resource Area**
Route 3, Box 181
Cottonwood, ID 83522 (962-3245)

U.S. ARMY CORPS OF ENGINEERS
FIELD OFFICES

Map #6

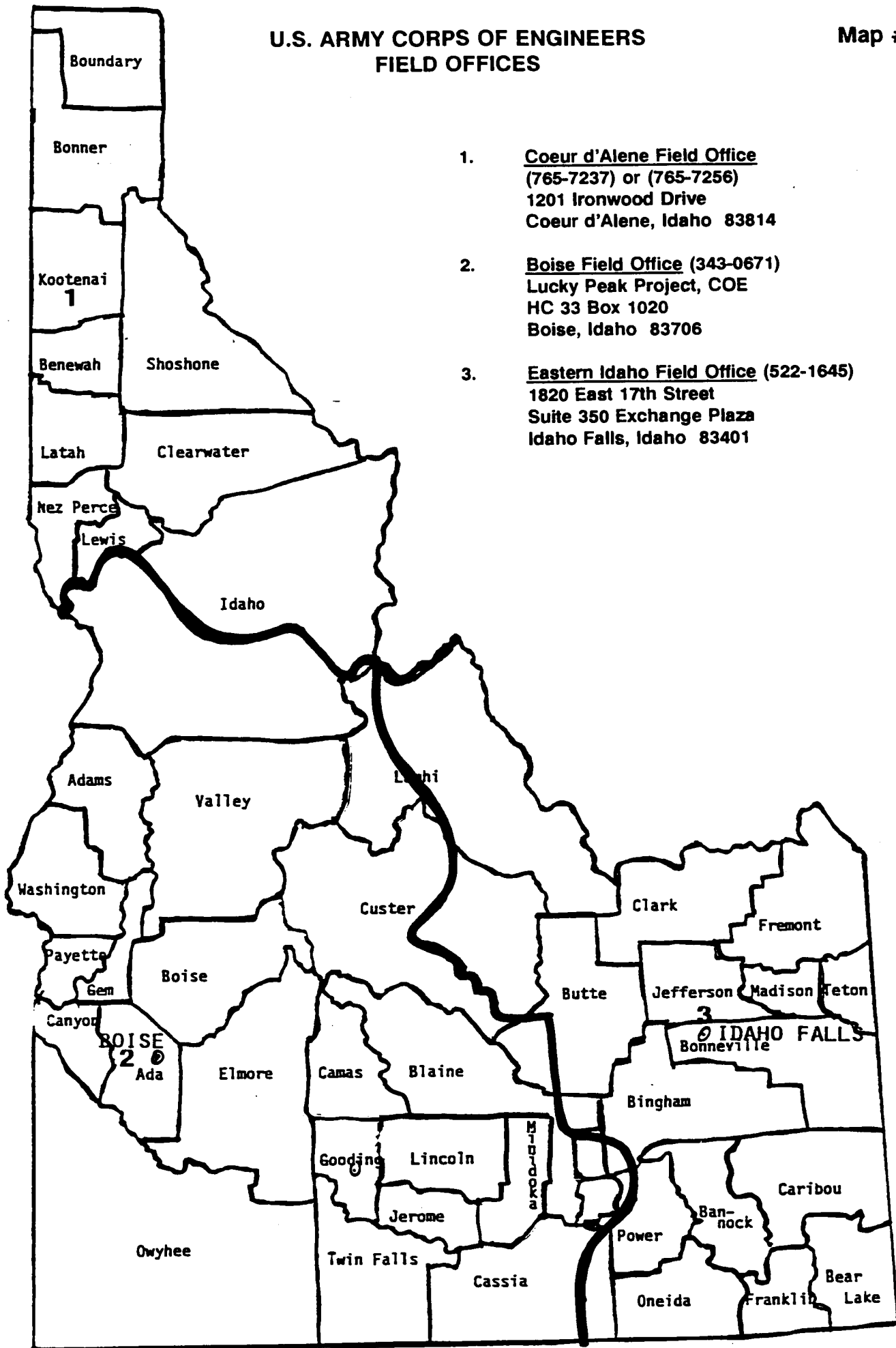

1. Coeur d'Alene Field Office
(765-7237) or (765-7256)
1201 Ironwood Drive
Coeur d'Alene, Idaho 83814
2. Boise Field Office (343-0671)
Lucky Peak Project, COE
HC 33 Box 1020
Boise, Idaho 83706
3. Eastern Idaho Field Office (522-1645)
1820 East 17th Street
Suite 350 Exchange Plaza
Idaho Falls, Idaho 83401

NATIONAL FORESTS OF IDAHO

Table #1

The personnel at the following national forest offices will direct you to the appropriate geologist:

BOISE NATIONAL FOREST

1750 Front Street
Boise, Idaho 83702
(208) 364-4100

CARIBOU NATIONAL FOREST

Federal Building, Suite 187
250 South 4th Avenue
Pocatello, Idaho 83201
(208) 236-7500

CHALLIS NATIONAL FOREST

Highway 93 North
HC 63 BOX 1671
Challis, Idaho 83226-9304
(208) 879-2285

PAYETTE NATIONAL FOREST

106 East Park Street
P.O. Box 1026
McCall, Idaho 83638
(208) 634-0700

SALMON NATIONAL FOREST

Forest Service Building
Highway 93 North
P.O. Box 729
Salmon, Idaho 83467
(208) 756-2215

SAWTOOTH NATIONAL FOREST

2647 Kimberly Road East
Twin Falls, Idaho 83301-3200
(208) 737-3200

TARGHEE NATIONAL FOREST

420 North Bridge Street
P.O. Box 208
St. Anthony, Idaho 83445
(208) 624-3151

CLEARWATER NATIONAL FOREST

12730 Highway 12
Orofino, Idaho 83544
(208) 476-4541

NEZ PERCE NATIONAL FOREST

Route 2, Box 475
Grangeville, Idaho 83530
(208) 983-1950

IDAHO PANHANDLE NATIONAL FOREST

3815 Schreiber Way
Coeur d'Alene, Idaho 83814-8363
(208) 765-7223

OTHER U.S. AGENCIES

TABLE #2

U.S. ENVIRONMENTAL PROTECTION AGENCY

422 West Washington (208) 334-1450
Boise, Idaho 83702

U.S. FISH AND WILDLIFE SERVICE

4696 Overland Road, Room 576 (208) 334-1931
Boise, Idaho 83705

NATIONAL MARINE FISHERIES SERVICE

525 N.E. Oregon Street, Suite 500 (503) 230-5400
Portland, Oregon 97232

IDAHO DEPARTMENT OF LANDS
1215 West State Street
Boise, Idaho 83720
Telephone: (208) 334-0261

APPLICATION FOR PLACER MINE PERMIT APPROVAL

General Information

The Idaho Dredge and Placer Mining Protection Act, Idaho Code Title 47, Chapter 13 requires any operator of a dredge or placer mining operation to obtain a Placer Mine Permit and bond. There is a \$50.00 application fee required for each 10 acres of land, or portion thereof, which is being permitted. **If a Stream Channel Alteration Permit is required for the operation, it must be issued prior to issuance of the Placer Mine Permit.**

When an applicant will be mining on lands administered by the U.S. Forest Service or Bureau of Land Management, it is necessary to obtain the proper federal approvals in addition to the Department of Lands. Each agency's application requirements are similar but not exactly the same. Please review both state and federal application requirements, and develop one plan which meets the requirements of the agency(ies) involved.

After the mine plan has been finalized, five (5) copies of this application must be submitted to the Idaho Department of Lands, Bureau of Minerals, at the above address. When the department receives an application, the appropriate federal agency will be notified of said application, and it will be reviewed for completeness within fourteen (14) days.

All placer mine permit applications will be processed in accordance with Rule 8 of the Rules and Regulations Governing Exploration and Placer Mining Operations In Idaho and applicable Memorandums of Understanding with state and federal agencies.

When the Department of Lands determines, in consultation with the DEQ, that there is an unreasonably high potential for nonpoint source pollution of adjacent surface waters, baseline pre-project surface water monitoring information will be required. (Rule 7.b.v.)

An out-of-state permittee is required to designate an in-state agent authorized to act on behalf of the permittee. If the applicant is not the owner of the lands described in the application, the land owner is required to endorse the application prior to permit issuance.

APPLICATION INFORMATION

1. Name _____
d/b/a _____
Address _____ 3. Telephone _____

4. Claim Name(s) _____

 Claim Owner(s) _____

6. Designated In-state Agent and Address: _____

7. Legal Description to the ¼-¼ _____
 Section _____ Township _____, Range _____

8. Acreage: _____ (include map as outlined on Page 2) 9. County: _____

10. The Operations Will Be Conducted On _____ Administered Lands
 (USFS, BLM, IDL or Private)

11. Describe How to Get to Mining Operation: _____

12. Describe the Mining Operation Including Commodity Type, Proposed Start-up Date, Mining Method, Equipment to be Used, and Duration of Operations on an Annual Basis and for the Life of the Project: (Use additional sheets, if necessary) _____

13. Please Provide the Following Maps of Your Mining Operation (Rule 7.d):
- a. A vicinity map prepared on a standard USGS 7.5' quadrangle map or equivalent.
 - b. A site map which adequately shows the location of existing roads, access roads, and main haul roads, which would be constructed or reconstructed for the operation. Also, list the approximate dates for construction, reconstruction and abandonment.
 - c. Show the location and names, if known, of all streams, creeks or bodies of water within 1,000 feet of the surface mining operation.
 - d. Show the approximate boundaries of the lands which will be affected by the mining operation. This map must be of adequate scale for boundary identification.
 - e. Show the approximate boundaries and acreage of the lands that will become affected by the mining operation during the first year of operations.
 - f. Show the planned location of all tailings ponds and ancillary structures associated with the mining operation.
 - g. Show the planned configuration of all pits, settling ponds, mineral stockpiles and overburden piles which will be developed by the mining operation.
 - h. Develop a surface and mineral control or ownership map of appropriate scale for boundary identification.

- i. Develop scaled cross sections of the mine showing surface profiles prior to mining at maximum disturbance and after reclamation.
- j. Show the location of required settling ponds, the design plans, construction specifications and narrative to show they meet both operating requirements and protection from erosion, seepage, and flooding that can be anticipated in the area. Where a dredge is operating in a stream, describe by drawing and narrative, the operation of the filtration equipment to be used to clarify the water.

Detailed plans and specifications for settling ponds shall be drawn to a scale of 1 inch = 10 feet and include the following:

- (1) A detailed map of the settling pond location, including:
 - (a) dimensions and orientation of the settling ponds and/or other wastewater treatment components of the operation;
 - (b) distance from surface waters;
 - (c) pond inlet/outlet locations including emergency spillways and detailed description of control structures and piping;
 - (d) location of erosion control structures; and
 - (e) 10-year flood elevation (probable high water mark).
- (2) A detailed cross-section of the pond(s) including:
 - (a) dimensions and orientation;
 - (b) proposed sidewall elevations;
 - (c) proposed sidewall slope;
 - (d) sidewall width;
 - (e) distance from and elevation above all surface water; and
 - (f) slope of settling pond location.
- (3) Narrative of the construction method(s) describing:
 - (a) bottom material;
 - (b) sidewall material;
 - (c) pond volume;
 - (d) volume of water to be used in the wash plant;
 - (e) discharge or land application requirements;
 - (f) any pond liners or filter materials to be installed; and
 - (g) compaction techniques.

If the proposed ponds are:

- (a) less than 2,500 feet² surface area;
- (b) less than four (4) feet high;
- (c) greater than fifty (50) feet from surface water; and
- (d) constructed on slopes of 3:1 or flatter;

the plans and specifications for settling ponds shall contain information in items (1) a, b, and d; (2) a, b, e and f. This information may be prepared as a sketch map showing appropriate elevations, distances and other required details.

- 14. An operator must prepare a document which identifies and assesses the foreseeable, site-specific, nonpoint sources of water quality impacts upon adjacent surface waters, and the best management practices the applicant will use to control the nonpoint source impacts.
- 15. A reclamation plan must be developed and submitted in map and narrative form. The reclamation plan must include the following information:
 - a. Show how watercourses disturbed by the mining operation shall be replaced on meander lines with a pool structure conducive to good fish and wildlife habitat and recreational use. Show how and where riprap or other methods of bank stabilization will be used to ensure that, following abandonment, the stream erosion will not exceed the rate normally experienced in the area. If necessary, show how the replaced watercourse will not contribute to degradation of water supplies;

- b. On a drainage control map show and list the Best Management Practices which will be utilized to control erosion on or from the affected lands.
- c. On a site map show which roads will be reclaimed, the approximate dates for reclamation, and describe the reclamation to be accomplished.
- d. Develop a revegetation plan which identifies how topsoil or other growth medium will be salvaged, stored and replaced in order to properly revegetate the area, identify the type of soil to be replaced, the slope of the reclaimed areas, and precipitation rates. Based on this information, identify the seed species, the seeding rates, the time and method of planting the soil, and fertilizer and mulch requirements.
- e. Describe and show how tailings or sediment ponds will be reclaimed.
- f. Make premining estimate of the number and species of trees on site.
- g. Estimate the actual cost of reclamation which includes the cost for equipment mobilization, regrading, seed, fertilizer, mulch, labor and any other pertinent costs.

Date: _____ Applicant Signature _____

Date: _____ Land Owner Signature _____

IDAHO DEPARTMENT OF LANDS
1215 West State Street
Boise, Idaho 83720
Telephone: (208) 334-0261

APPLICATION FOR RECLAMATION PLAN APPROVAL

GENERAL INFORMATION

The Idaho Surface Mining Act, Idaho Code title 47, chapter 15, requires an operator of a surface mining operation to obtain an approved reclamation plan and bond. There is no fee required.

When an applicant is mining on lands administered by the U.S. Forest Service or Bureau of Land Management, it is necessary to obtain the proper federal approvals in addition to the Department of Lands. Each agency's application requirements are similar, but not exactly the same. Please review both state and federal application requirements, and develop one plan which meets the requirements of the agency(ies) involved.

After the mine plan has been finalized, five (5) copies of this application must be submitted to the Idaho Department of Lands, Bureau of Minerals, at the above address. When the department receives an application, the appropriate federal agency will be notified of said application, and it will be reviewed for completeness within seven (7) days.

All reclamation plan applications will be processed in accordance with Section 70 of the Administrative Rules Governing Exploration and Surface Mining Operations in Idaho and applicable Memorandums of Understanding with state and federal agencies.

APPLICATION INFORMATION

1. NAME _____ d/b/a _____
2. ADDRESS _____ 3. Telephone _____
4. CLAIM NAME(S) _____
5. CLAIM OWNER(S) _____
6. DESIGNATED IN-STATE AGENT AND ADDRESS: _____

7. LEGAL DESCRIPTION TO THE QUARTER-QUARTER SECTION: _____
8. ACREAGE _____ 9. County(ies) _____
(Include map outlined on page 2)
10. OWNERSHIP: Private, U.S. Forest Service, Bureau of Land Management or Idaho Department of Lands
(circle one)
11. COMMODITY TYPE, DURATION OF OPERATION, PROPOSED START-UP DATE _____

(over)

12. Please provide the following maps of your mining operation (Section 070.03):
- a. A vicinity map prepared on a standard USGS 7.5' quadrangle map or equivalent.
 - b. A site map which adequately shows the location of existing roads, access roads, and main haul roads, which would be constructed or reconstructed for the operation. Also, list the approximate dates for construction, reconstruction and abandonment. (Section 070.03.a)
 - c. On a site location map show the location and names, if known, of all streams, creeks or bodies of water within 1,000 feet of the surface mining operation.
 - d. On a site location map show the approximate boundaries and acreage of the lands that will become affected by the mining operation. This map must be of adequate scale for boundary identification.
 - e. On a site location map show the approximate boundaries and acreage of the lands that will become affected by the mining operations during the first year of operations.
 - f. On a site location map show the planned location of all tailings ponds and ancillary structures associated with the mining operation.
 - g. On a site location map show the planned configuration of all pits, mineral stockpiles and overburden piles which will be developed by the mining operation.
 - h. Develop a surface and mineral control or ownership map of appropriate scale for boundary identification.
 - i. Develop scaled cross-sections of the mine showing surface profiles prior to mining at maximum disturbance and after reclamation.
13. A reclamation plan must be developed and submitted in map and narrative form (Section 070.04). The reclamation plan must include the following information:
- a. On a drainage control map show and list the best management practices which will be utilized to control erosion on or from the affected lands
 - b. On a site map show which roads will be reclaimed, the approximate dates for reclamation, and describe the reclamation to be accomplished.
 - c. Develop a revegetation plan which identifies how topsoil or other growth medium will be salvaged, stored and replaced in order to properly revegetate the area, identify the type of soil to be replaced, the slope of the reclaimed areas, and precipitation rates. Based on this information, identify the seed species, the seeding rates, the time and method of planting the soil, and fertilizer and mulch requirements.
 - d. Describe and show how tailings or sediment ponds will be reclaimed.
 - e. Estimate the actual cost of reclamation which includes the cost for equipment mobilization, regrading, seed, fertilizer, mulch, labor and any other pertinent costs.

APPLICANT SIGNATURE: _____

DATE _____

CANADA

APPENDIX D.I

POTENTIAL PRECIPITATION MAP FOR IDAHO

Produced
by the
Idaho Transportation Department

WASHINGTON

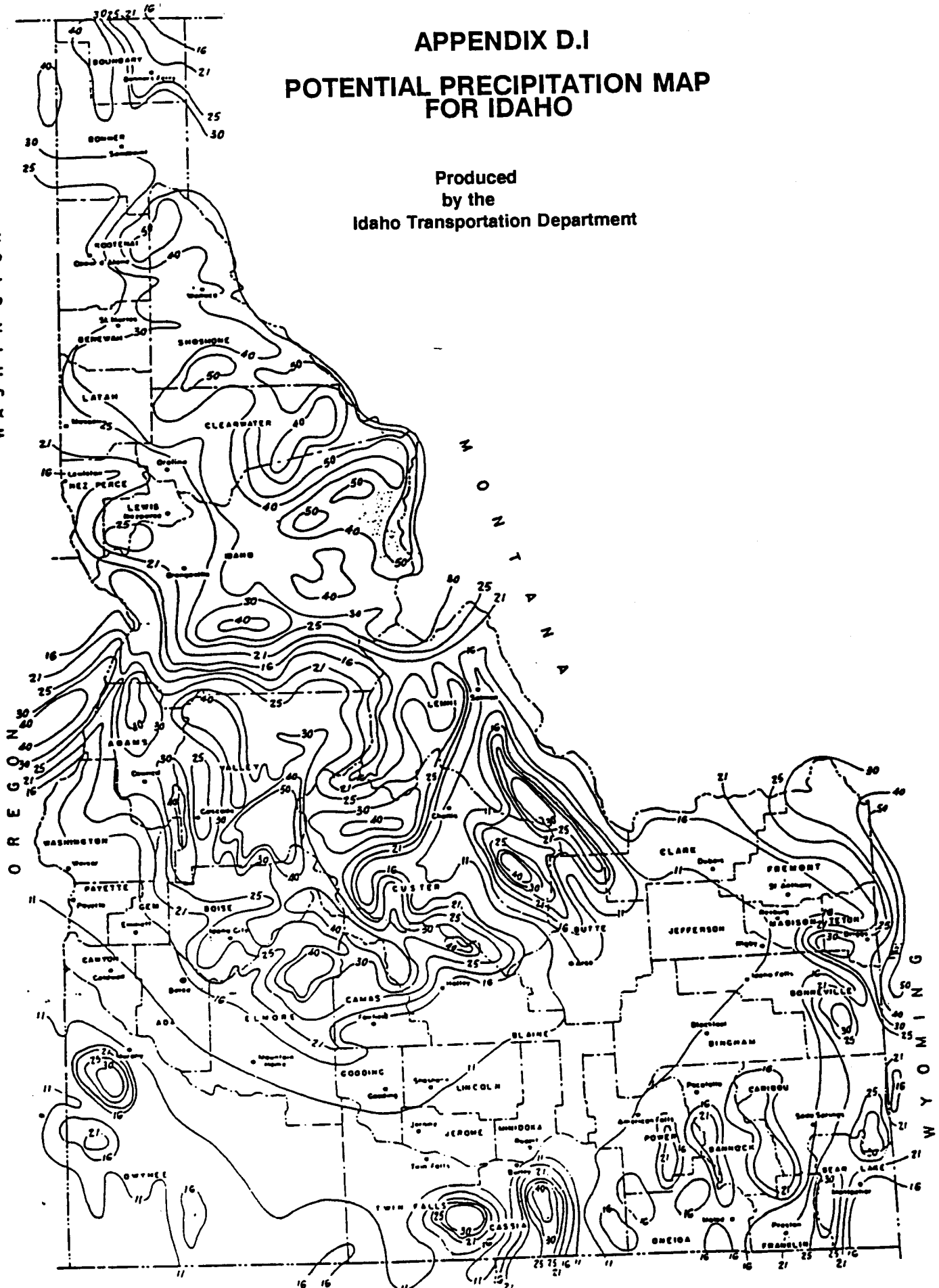

OREGON

MONTANA

WYOMING

NEVADA

UTAH

APPENDIX D.II

POTENTIAL PLANT SPECIES FOR RECLAIMING DISTURBED SITES

Produced by Ben Albrechtsen
U.S. Forest Service Region 4 Reclamation Specialist

SPECIES FOR SALT DESERT SHRUB AREAS - 6-10" PRECIPITATION

GRASSES

<u>Common Name</u>	<u>Scientific Name</u>	<u>Variety/Cultivar</u>
Indian ricegrass	Oryzopsis hymenoides	
Needle and threadgrass	Stipa comata	
Desert Wheatgrass	Agropyron desertorum	Standard
Squirrel tail	Sitanion hystrix	
Galleta grass	Hilaria jamesii	

FORBS

<u>Common name</u>	<u>Scientific Name</u>	<u>Variety/Cultivar</u>
Small burnet	Sanguisorba minor	
Gooseberry globemallow	Sphaeralcea grossulariaefolia	
Prostrate summercress	Kochia prostrata	
Palmer penstemon	Penstemon palmeria	
Utah vetch	Hedysarum boreale	Utahensis

SHRUBS

<u>Common Name</u>	<u>Scientific Name</u>	<u>Variety/Cultivar</u>
Shadscale	Atriplex confertifolia	
Fourwing saltbrush	Atriplex canescens	
Nuttal saltbrush	Atriplex nuttallii	
Winterfat	Ceratoides lanata	
Spiney hopsage	Grayia spinosa	
White burr sage	Franseria drumosa	

SPECIES FOR SAGEBRUSH-FOOTHILL AREAS - 10-13" PRECIPITATION

GRASSES

<u>Common Name</u>	<u>Scientific Name</u>	<u>Variety/Cultivar</u>
Crested Wheatgrass	Agropyron cristatum	Fairway, Ephraim
Pubescent wheatgrass	Agropyron trichophorum	
Intermediate wheatgrass	Agropyron intermedium	
Streambank wheatgrass	Agropyron riparium	
Western wheatgrass	Agropyron smithii	
Bluebunch wheatgrass	Agropyron spicatum	
Thickspike wheatgrass	Agropyron dasystachyum	
Indian ricegrass	Oryzopsis hymenoides	
Squirrel tail	Sitanion hystrix	
Needle and threadgrass	Stipa comata	
Sheep fescue	Festuca ovina	Durar

FORBS

<u>Common Name</u>	<u>Scientific Name</u>	<u>Variety/Cultivar</u>
Small burnet	Sanguisorba minor	Utahensis Nomad or Ladak
Western yarrow	Achillea millefolium	
Palmer penstemon	Penstemon palmeri	
Utah vetch	Hedysarum boreale	
Cicer milkvetch	Astragalus cicer	
Alfalfa	Meticago sativa	
Yellow sweetclover	Melilotus officinalis	
Lewis flax	Linum lewisii	
Silver sage	Artemisia frigida	
Sulfur buckwheat	Eriogonum umbellatum	

SHRUBS

Blacksage	Artemisia nova	Wyomingensis Vaseyana
Low sage	Artemisia arbuscula	
Wyoming big sagebrush	Artemisia tridentata	
Mountain big sagebrush	Artemisia tridentata	
Tarragon	Artemisia dracunculus	
Rabbitbrush	Chrysothamnus vicidiflorus	
Fourwing saltbrush	Atriplex canescens	
Winterfat	Ceratoides lanata	
Curleaf mahogany	Cercocarpus ledifolius	
Mountain mahogany	Cercocarpus montanus	

D2-B

**SPECIES FOR SAGEBRUSH/PINYON-JUNIPER/MOUNTAINBRUSH AREA
13-18" PRECIPITATION**

GRASSES

<u>Common Name</u>	<u>Scientific Name</u>	<u>Variety/Cultivar</u>
Intermediate wheatgrass	Agropyron intermedium	
Pubescent wheatgrass	Agropyron trichophorum	
Bluebunch wheatgrass	Agropyron spicatum	
Western wheatgrass	Agropyron smithii	
Streambank wheatgrass	Agropyron riparium	
Crested wheatgrass	Agropyron cristatum	Ephraim, Fairway
Basin wildrye	Elymus cinereus	
Sheep fescue	Festuca ovina	Durar
Thurbers fescue	Festuca thurberi	
Indian ricegrass	Oryzopsis hymenoides	
Blg bluegrass	Poa ampla	
Canada bluegrass	Poa compressa	
Canby bluegrass	Poa canbyi	
Sandberg bluegrass	Poa secunda	
Smooth brome	Bromas inermis	
Needle and threadgrass	Stipa comata	
Columbia needlegrass	Stipa columblana	
Prairie junegrass	Koleria cristata	
Tufted hairgrass	Deschampsia caespitosa	
Orchard grass	Dactylis glomerata	Plaute

FORBS

<u>Common Name</u>	<u>Scientific Name</u>	<u>Variety/Cultivar</u>
Alfalfa	Meticago sativa	
Cicer milkvetch	Astragus cicer	
Utah vetch	Hedysarum boreale	Utahensis
Small burnet	Sanguisorba minor	
Western yarrow	Achillea millifolia	
Lewis flax	Linum lewisii	
Sulfur buckwheat	Eriogonum umbellatum	
California buckwheat	Eriogonum pacifica	
Sanfoin	Onobrychis viciafolium	
Palmer penstemon	Penstemon palmeri	
Aster	Aster adscendens	
Geranium	Geranium richardsonii	
Yellow sweetclover	Mellilotus officianalis	
Clematis	Clematis ligusticifolia	

D2-C

**SPECIES FOR SAGEBRUSH/PINYON-JUNIPER/MOUNTAINBRUSH AREA
13-18" PRECIPITATION**

SHRUBS

<u>Common Name</u>	<u>Scientific Name</u>	<u>Variety/Cultivar</u>
Desert bitterbrush	Purshia glandulosa	
Bitterbrush	Purshia tridentata	
Cliffrose	Corvania mexicana	
Elderberry	Sambucus cerulea	
Prostrate Summercress	Kochia prostrata	
Mountain mahogany	Cercocarpus montanus	
Curlleaf mahogany	Cercocarpus ledifolius	
Sagebrush	Artemisia tridentata	Wyomingensis or vaseyana
Blacksage	Artemisia nova	
Lowsage	Artemisia arbuscula	
Tarragon	Artemisia drucunculus	
Fourwing saltbrush	Atriplex canescens	
Winterfat	Ceratoides lanata	
Serviceberry	Amelanchier alnifolia	
Gooseberry	Ribes velutinum	
Mountain snowberry	Symphoricarpus oreophyllus	
Woods rose	Rosa woodsii	

SPECIES FOR UPPER MOUNTAIN ELEVATIONS - 19-25" PRECIPITATION

GRASSES

<u>Common Name</u>	<u>Scientific Name</u>	<u>Variety/Cultivar</u>
Smooth brome	Bromus inermis	
Mountain brome	Bromus marginatus	
Meadow fescue	Festuca elatior	
Tall fescue	Festuca arundinacea	
Sheep fescue	Festuca ovina	Durar
Tall oat grass	Arrhenatherum elatius	
Intermediate wheatgrass	Agropyron intermedium	
Pubescent wheatgrass	Agropyron pubescens	
Western wheatgrass	Agropyron smithii	
Orchard grass	Dactylis glomerata	
Timothy	Phleum pratense	
Idaho fescue	Festuca idahoensis	
Kentucky bluegrass	Poa pratensis	
Big bluegrass	Poa ampla	
Canada bluegrass	Poa compressa	
Sandberg bluegrass	Poa secunda	

FORBS

<u>Common Name</u>	<u>Scientific Name</u>	<u>Variety/Cultivar</u>
Alfalfa	Medicago sativa	Ladak or Nomad
Cicer milkvetch	Astragalus cicer	
Utah vetch	Hedysarum boreale	Utahensis
Western yarrow	Achillea millefolora	
Small burnet	Sanguisorba minor	
Mountain lupine	lupinus alpestris	
Silvery lupine	Lupinus argenteus	
Palmer Penstemon	Penstemon palmeri	
Utah Penstemon	Penstemon utahensis	
Rocky mountain penstemon	Penstemon strictus	
Sanfoin	Onobrychis vicidiflorum	
Pacific aster	Aster adscendens	
Strawberry	Frageria virginiana	
Crown vetch	Cornoilla varia	
Alpine leafy bract aster	Aster foliaceus	
White dutch clover	Trifolium repens	
Red clover	Trifolium pratense	

SPECIES FOR UPPER MOUNTAIN ELEVATIONS - 19-25" PRECIPITATION

SHRUBS

<u>Common Name</u>	<u>Scientific Name</u>	<u>Variety/Cultivar</u>
Raspberry	Rubus idaeus	
Snowberry	Symphoricarpus oreophilus	
Bush cinquefoil	Potentilla fruticosa	
Chokecherry	Prunus virginiana	
Elderberry	Sambucus cerulea	
Mountain big sagebrush	Artemisia tridentata	vaseyana
Serviceberry	Amalanchier alnifolia	
Silver sage	Artemisia cana	visidula
Louisiana sage	Artemisia ludoviciana	
Currant	Ribes lacustre	
Woods Rose	Rosa woodsii	
Willow	Salix spp. (local)	

**APPENDIX D.III
SEED SUPPLIERS**

Bitterroot Native Growers
445 Quast Lane
Corvallis, Montana 59828
Telephone: (406) 961-4991
Fax: (406) 961-4873

Foulger Seed Company
6950 S. 400 W. #1
Midvale, Utah 84047
Telephone: (801)255-1131

Granite Seed
P.O. Box 177
Lehi, Utah 84043
Telephone (801) 283-6639
Fax: (801) 768-3967

Intermountain Seed Co.
P.O. Box 62
Ephraim, Utah 84627
Telephone: (801) 283-4383

Kester's Wild Game Food Nurseries
P.O. Box 516
Omro, Wisconsin 54963
Telephone: (414) 685-2929

Maple Leaf Industries
480 South 50 East
Ephraim, Utah 84627
Telephone: (801) 283-4701

Plant Genetics, Inc.
1918 South Middleton Rd.
Nampa, Idaho 83686
Telephone: (208) 466-0829

Sharp Brothers Seed Co.
101 East Fourth Street Rd.
Greeley, Colorado 80631
Telephone: (303) 356-4710

Stevenson Intermountain Seed
P.O. Box 2
Ephraim, Utah 84627
Telephone: (801) 768-4422

Union Seed Co.
P.O. Box 339
Nampa, Idaho 83653
Telephone: (208) 466-3568

Westland Seed, Inc
1308 Round Butte Road
Ronan, Montana 59864
Telephone: (406) 676-4100

Davenport Seed Corporation
1404 Fourth Street
Davenport, Washington 99122
Telephone (509)725-7015

APPENDIX D.IV

EROSION CONTROL AND SOIL STABILIZATION PRODUCTS

American Excelsior Company
350 North Redwood
Salt Lake City, Utah 84054
Telephone: (801) 292-6060

American Excelsior Company
609 South Front Street
Yakima, Washington 98901
Telephone: (509) 575-5794

Spokane Culvert Company
4778 Dorman
Boise, Idaho 83705
Telephone: (208) 344-2570

Terra Enterprises
P.O. Box 9485
Moscow, Idaho 83843
Telephone: (208) 882-9489

North American Green, Boise Distr.
Water and Wastewater Equipment
5200 Bethel
Boise, Idaho 83707
Telephone: (208) 377-0440
Fax: (208) 377-0493

GLOSSARY OF TERMS

Acid Mine Drainage - acid drainage from adits or surface mine structures such as waste dumps that contains a high concentration of acidic sulfates, especially ferrous sulfate. Acid mine drainage results from the oxidation and hydrolysis of sulfides in spoil material.

Exploration - the work of investigating a mineral deposit to determine by geological surveys, geophysical surveys, geochemical surveys, bore holes, pits, and underground workings if it is feasible to mine. Exploration is undertaken to gain knowledge of the size, shape, position, characteristics, and value of the deposit.

Ecosystem - an interacting system of a biotic community and its environment.

Free board - the difference in elevation between the maximum operating water surface or top of the impoundment dam or embankment and the low point on the upstream edge of the crest. At minimum the free board must be two (2) feet plus the wave height at design flood conditions.

Ground Water - water at or below the water table. A broad definition includes all water below the surface of the ground.

Highwall - (1) the excavation face of exposed overburden and bedrock in a surface mine; (2) the face or bank on the uphill side of a contour mine.

Hydrostatic Pressure - pressure of a liquid under static (motionless) conditions.

Leachates - liquid that has been percolated through a soil or other medium that might contain dissolved metals or other potentially toxic substances.

Major Storm Event - 100 year 24-hour storm event. The maximum amount of precipitation that has fallen in a 24 hour period during the past 100 years (or for as long as records have been kept).

Mitigate - to cause to become less severe; to alleviate.

Nonpoint Source (surface water) - a source of surface water pollution that is diffuse and intermittent resulting from land surface disturbing activities such as mining, grazing, agriculture, or forest practices. Source of pollution that can not be traced to a specific, identifiable point of entrance into a waterway.

Nonpoint Source (ground water) - a potential source of ground water contamination that is diffuse and intermittent.

Overburden - soil, rock, and other materials which overlie mineral deposits and are removed in surface mining.

Oxidation - (oxidize) to combine with oxygen.

pH - Measure of acidity or alkalinity. Low pH denotes acidic conditions, high pH alkaline conditions. A pH of 6.5-7 is considered neutral.

Piping - the movement of soil particles by percolating water, leading to the

development of channels.

Pore Pressure - stress transmitted through the pore water (water filling the voids of soil).

Riparian Area - an area of land that is comprised of aquatic and riparian ecosystems and may include the adjacent terrestrial ecosystem if it directly influences the riparian or aquatic system. This zone extends approximately 100 feet on each side of the normal high water mark of a stream channel but may vary in width depending on local topography or land modifications.

Sulfides - compound of sulfur with more than one element.

Sulfidic waste - waste containing sulfide minerals.

References Cited

Abandoned Mine Tailings Reclamation Alternatives for Idaho, Idaho Department of Health and Welfare - Division of Environmental Quality, University of Idaho, College of Mines, January 1980.

A Dictionary of Mining, Mineral and Related Terms, United States Department of Interior, Bureau of Mines ed. by Paul W. Thrush. 1968.

A Guide to Reclaiming Small Tailings Ponds and Dumps, USDA General Technical Report INT-57 Gerald Harwood, ed. 1979.

A Guide to the Use of Organic Material as Mulch in Reclamation of Coal Mine Soil in the Eastern United States. Bernard M. Slick, Willie R. Curtis. USDA Forest Service, General technical Report NE-98, 1985.

Best Management Practices: A Guide to Resource Management and Reclamation of Mined Lands in the Black Hills of South Dakota.

Best Management Practices for Placer Mining Technical Report, Alaska Department of Fish and Game, January, 1986.

Best Management Practices for Roads, Volumes I and II, prepared by Carla L. Levinski, Idaho Department of Health and Welfare - Division of Environmental Quality, August 1982.

Construction Costs and Erosion Control Effectiveness of Filter Windrows on Fill Slopes, Michael J. Cook and John G. King. USDA Forest Service Research Note INT-335, Ogden, Utah.

Design and Construction of Tailings Dams, ed. by David Wilson, Colorado School of Mines, Golden, Colorado, July, 1981.

Design of Dams for Mill Tailings, C.D. Kealy and R.L. Soderberg, United States Bureau of Mines Information Circular 8410, 1969

Handbook of Best Management Practices, State of Nevada.

Idaho Nonpoint Source Management Program Plan, Idaho Department of Health and Welfare - Division of Environmental Quality, May, 1989.

Placer Mining in Alaska, A Guide to Mitigation and Reclamation, United States Department of Interior, Bureau of Land Management, 1989.

Processes, Procedures and Methods to Control Pollution From Mining Activities, United States Environmental Protection Agency, Washington, D.C., October, 1973.

Reclamation and Pollution Control: Planning Guide for Small Sand and Gravel Pits, United States Department of Interior, Bureau of Mines.

Reclamation and Vegetative Restoration of Problem Soils and Disturbed Lands,
Darrell Brown et al, Noyes Data Corporation, Park Ridge, New Jersey, 1896.
Reclamation Field Guide, Region 4, United States Department of Agriculture
Forest Service, Ogden, Utah.

Reclamation Technology for Tailings Impoundments, Part 1, Containment,
Richard C. Brath, Mineral and Energy Resources, January, 1986.

Settling Ponds as a Wastewater Treatment Facility, Roy E. Williams and Leland
L. Mink, Idaho Geologic Survey Pamphlet No. 164, December, 1975.

Settling Pond Handbook, written by the Alaska Department of Environmental
Conservation, 1981, later edited by the Montana Department of Health and
Environmental Science, Water Quality Bureau and Montana Department of
Lands, 1982.

SME Mining Engineering Handbook, Vol 1 and 2, Arthur B. Cummins and Ivan A.
Given editors, Society of Mining Engineers of the American Institute of Mining,
Metallurgical and Petroleum Engineers Inc, New York, New York, 1973.

Spill Response Plan for Stibnite Mine Project Transportation Routes, Pioneer
Metals Corporation.

1990 Spill Response Plan: Eastern Valley County, Idaho Mining Districts, Coeur
Thunder Mountain Inc., Hecla Mining Company, Pioneer Metals Corporation.

Technical Guide for Control of Water Pollution from Mining and Milling
Operations, Idaho Department of Health and Welfare - Division of Environmental
Quality, July, 1979.

Users Guide to Engineering, Mining and Reclamation in the West, U.S.D.A.
Forest Service, General Technical Report INT-70, Intermountain Forest and
Range Experiment Station, Ogden, Utah, December, 1979.

Users Guide to Hydrology, Mining and Reclamation in the West, U.S.D.A. Forest
Service, General Technical Report INT-74, Intermountain Forest and Range
Experiment Station, Ogden, Utah, January, 1980.